

November 22, 2002

For P31 owners who do not have the original owners manual, I felt that it was worthwhile to offer a copy of the one that came with my 1991 P31-II #268. The dates on the pages and drawings imply that the manual was changed little from 1998 on and is therefore applicable.

It also appears that Pearson used the same text for most of their manuals and inserted appropriate drawings for the specific model being shipped. The general information should be useful to all Pearson owners.

The final page contains Keel Bolt torque values for Pearson Models 27 through P39

I used OCR (Optical Character Recognition) software to read the manual and convert it into Word 6.0. This allowed me to keep the size of the file as low as possible for downloading. The pages that have drawings on them were scanned as .bmp bit maps. These were inserted into the word document.

Bill Crane  
P31-II Talaria  
[Billlosail@aol.com](mailto:Billlosail@aol.com)

**TABLE OF CONTENTS**

QUICK REFERENCE LOCATION SHEET	
<b>INTRODUCTION</b>	<b>SECTION 1</b>
INTRODUCTION	1.1
FORMAT	1.2
WARRANTY	1.3
OWNER RESPONSIBILITY	1.4
<b>COMMISSIONING</b>	<b>SECTION 2</b>
<b>INTRODUCTION</b>	<b>2.1</b>
<b>PRE-LAUNCH CHECKS</b>	<b>2.2</b>
Hull Inspection	2.2.1
Machinery Inspection	2.2.2
Before Mast Is Stepped	2.2.3
Equipment On Board	2.2.4
<b>POST-LAUNCH CHECKS</b>	<b>2.3</b>
Hull Inspection	2.3.1
Electrical Inspection	2.3.2
Machinery Inspection	2.3.3
Rigging and Sails	2.3.4
Fresh Water System	2.3.5
Head System	2.3.6
Galley	2.3.7
<b>OWNER RESPONSIBILITY</b>	<b>2.4</b>
Mandatory Coast Guard Equipment	2.4.1
Recommended Safety Equipment	2.4.2
Ground Tackle	2.4.2.1

Medical Kit	2.4.2.2
Tool Kit	2.4.2.3
Spare Parts	2.4.2.4
Additional Safety Equipment	2.4.3
Dealer Responsibility	2.4.4
<b>YACHT SYSTEMS - SPARS AND RIGGING</b>	<b>SECTION 3</b>
<b>MAST</b>	<b>3.1</b>
Masthead Assembly	3.1.2
Spreaders and Standing Rigging	3.1.3
<b>BOOM</b>	<b>3.2</b>
Continuou3 Line Reefing (internal )	3.2.1
<b>DOCKSIDE TUNING</b>	<b>3.3</b>
Before Mast is Stepped	3.3.1
While Stepping Mast	3.3.2
After Stepping Mast	3.3.3
Rake Adjustment	3.3.3.1
Side-to-Side Perpendicularity	3.3.3.2
<b>UNDERWAY TUNING</b>	<b>3.4</b>
Weather Helm	3.4.1
<b>CARE AND MAINTENANCE</b>	<b>3.5</b>
Rigging and Lines	3.5.1
Winches	3.5.2
<b>YACHT SYSTEMS - POWER</b>	<b>SECTION 4</b>
<b>GENERAL DESCRIPTION</b>	<b>4.1</b>
<b>DIESEL - OPERATION</b>	<b>4.2</b>
Additional Controls	4.2.1

Before Starting	4.2.2
Starting	4.2.3
Stopping	4.2.4
<b>DIESEL - MAINTENANCE</b>	4.3
Fuel Sanitation	4.3.1
Bacterial Contamination	4.3.2
Fuel Additives	4.3.3
<b>FUEL SYSTEM - GENERAL DESCRIPTION</b>	4.4
FUEL SYSTEM - FUELING	4.5
Before Fueling	4.5.1
Fueling Procedures	4.5.2
After Fueling	4.5.3
Oil Pan & Caution	4.5.4
<b>PROPELLER AND SHAFT ASSEMBLY</b>	4.6
Shaft Packing Gland	4.6.1
Adjustment	4.6.1.1
Shaft Coupling	4.6.2
Flex Coupling	4.6.2.1
To Disconnect Coupling	4.6.2.2
To Check Alignment	4.6.2.3
To Reconnect Coupling	4.6.2.4
<b>YACHT SYSTEMS -</b>	SECTION 5
GENERAL DESCRIPTION	5.1
Messenger Lines	5.1.1
<b>BATTERY</b>	5.2
Electrolyte Level	5.2.1
Discharged State	5.2.2
Clear Connections	5.2.3

<b>LIGHTNING PROTECTION &amp; BONDING SYSTEMS</b>	5.3
Bonding System	5.3.1
Lightning Protection System	5.3.2
<b>UNDERWATER GALVANIC CORROSION</b>	5.4
Electrolysis	5.4.1
Checklist	5.4.2
Propeller and Shaft	5.5.1
Electrical Switches	5.5.2
External Factors	5.5.3
<b>YACHT SYSTEMS - STEERING</b>	SECTION 6
<b>GENERAL DESCRIPTION</b>	6.1
Wheel Steering System	6.1.1
Emergency Tiller	6.1.2
<b>YACHT SYSTEMS - HULL</b>	SECTION 7
<b>THRU-HULL FITTINGS</b>	7.1
<b>FRESH WATER SYSTEM</b>	7.2
Hot/Cold Pressure Water System	7.2.1
Water System Maintenance	7.2.2
<b>PROPANE SYSTEM</b>	7.3
Operation	7.3.1
General	7.3.2
<b>Head and Waste System</b>	7.4
<b>MAINTENANCE SUMMARY</b>	SECTION 8
<b>INTRODUCTION</b>	8.1
<b>ROUTINE MAINTENANCE</b>	8.2

Topsides, Decks and Below Decks	8.2.1
Gelcoat	8.2.1.1
Wood Surfaces	8.2.1.2
Window Maintenance	8.2.1.3
Below The Waterline	8.2.2
Bottom Cleaning	8.2.2.1
Bottom Preparation	8.2.2.2
Bottom Painting	8.2.2.3
Winches	8.2.3
Spars And Rigging	8.2.4
Cleaning Wire Rope and Rigging	8.2.4.1
Cleaning Synthetic Rope	8.2.4.2
Rigging Inspection	8.2.4.3
Engine System	8.2.5
Electrical System	8.2.6
Steering System	8.2.7
<b>LAYING UP</b>	8.3
Before Hauling	8.3.1
After Hauling	8.3.2
<b>FITTING OUT</b>	8.4

## LIST OF ILLUSTRATIONS

TITLE	FIGURE NUMBER
MASTHEAD ASSEMBLY	3.1.1
TYPICAL SPREADER INSTALLATION	3.1.2
RIGGING SCHEMATIC	3.1.3
CONTINUOUS LINE REEFING	3.2.1
MAST INSTALLATION	3.3.1
TIE ROD INSTALLATION	3.3.2
POWER SYSTEM SCHEMATIC	4.2
SHAFT ALIGNMENT	4.6
120 VOLT DC ELECTRICAL DIAGRAM	5.1
ELECTRICAL PANEL	5.2
BONDING SYSTEM	5.3
MAST AND INSTRUMENT WIRES	5.4
TRANSDUCER WIRE LEADS	5.4.1
EMERGENCY TILLER INSTALLATION	6.1
THRU-HULL LOCATION SCHEMATIC	7.1
FRESH WATER SYSTEM	7.2
TANK LOCATIONS	7.2.1
PROPANE SYSTEM SCHEMATIC	7.3
Y-VALVE, HOLDING TANK	7.4

For your convenience the following list of important locations on your Pearson has been included.

QUICK REFERENCE LOCATION SHEET

EMERGENCY TILLER	IN SAIL LOCKER
HEAD INTAKE VALVE	BELOW TRAP AT FWD END OF THE STBD SETTEE
HEAD OVERBOARD DISCHARGE VALVE	BELOW VANITY
DISCHARGE SELECT VALVE	BELOW VANITY
HOLDING TANK (24 gal.)	BELOW V-BERTH
ENGINE RAW WATER INTAKE VALVE	BELOW BUNK TRAP AFT OF ENGINE BOX, STBD SIDE
ENGINE RAW WATER STRAINER VALVE	BELOW ENGINE BOX FWD OF THE ENGINE
PROP SHAFT PACKING NUT	BELOW BUNK TRAP AFT OF ENGINE BOX ON CENTERLINE
ENGINE OIL DIP STICK	STBD SIDE OF ENGINE ACCESS PANEL ON STBD SIDE OF ENGINE BOX
TRANSMISSION OIL DIPSTICK	ON TRANSMISSION ACCESS BELOW TRAP AFT OF ENGINE BOX ON QUARTERBERTH TOP
OVERFLOW RESERVOIR BOTTLE	STBD SIDE OF ENGINE BELOW ENGINE BOX COVER
FUEL TANK	BELOW QUARTERBERTH BUNK TOP AFT END
FUEL GAUGE	ON FUEL TANK BELOW CUSHION
FUEL FILTER	BELOW BUNK TRAP AFT OF ENGINE BOX, STBD SIDE
FUEL "SHUT OFF" VALVE	ON FUEL FILTER
PROPANE TANK	PROPANE BIN, AFT END OF COCKPIT, PORT SIDE
PROPANE SOLENOID	PROPANE BIN
PROPANE SWITCH	ON ELECTRICAL PANEL AT NAV STATION ABOVE ICEBOX



BATTERIES	BELOW QUARTERBERTH, FWD END
BATTERY SELECT SWITCH	QUARTERBERTH FRONT BETWEEN ENGINE BOX AND BUREAU
DC ELECTRICAL PANEL	ABOVE ICEBOX AT NAV STATION
AC ELECTRICAL PANEL	ABOVE ICEBOX AT NAV STATION
SUMP PUMP	BELOW VANITY
SUMP PUMP SWITCH	HEAD LOCKER, FWD END
SUMP DISCHARGE VALVE	BELOW PORT SETTEE, FWD END
PORT WATER TANK (20 gal.)	BELOW PORT SETTEE, AFT END
STBD WATER TANK (20 gal.)	BELOW STBD SETTEE, AFT END
PORT TANK "SHUT OFF" VALVE	BELOW GALLEY SINK, PORT SIDE
STBD TANK "SHUT OFF" VALVE	BELOW GALLEY SINK, STBD SIDE
FRESH WATER FILTER	BELOW GALLEY SINK ON PRESSURE WATER MANIFOLD
FRESH WATER PRESSURE PUMP	BELOW GALLEY SINK
GALLEY SINK DRAIN	BELOW GALLEY SINK
VANITY SINK DRAIN	BELOW SETTEE, FWD END
ANCHOR LOCKER DRAIN	ON BOW STEM
DECK DRAIN (PORT)	SAIL LOCKER, FWD END
DECK DRAIN (STBD)	LAZARETTE AREA, AFT OF QUARTERBERTH BEHIND ACCESS PANEL, STBD SIDE
COCKPIT DRAINS	LAZARETTE AREA, AFT OF QUARTERBERTH BEHIND ACCESS PANEL, STBD SIDE
PROPANE BIN DRAIN	LAZARETTE AREA, AFT OF SAIL LOCKER BEHIND ACCESS PANEL, STBD SIDE
ICEBOX DRAIN	PUMP AT SINK, ACCESS DRAIN FITTINGS BELOW ICEBOX
WATER FILL (PORT TANK)	PORT SIDE DECK, MIDSHIP
WATER FILL (STBD TANK)	STBD SIDE DECK, MIDSHIP
FUEL FILL	COCKPIT COAMING, AFT PORT END

WASTE PUMP OUT	ANCHOR LOCKER, BOTTOM
WATER TANK VENT (PORT)	AFT END OF PORT SETTEE ON BULKHEAD
WATER TANK VENT (STBD)	AFT END OF STBD SETTEE ON BULKHEAD
FUEL TANK VENT	ON TRANSOM, UPPPER PORT CORNER
HOLDING TANK VENT	BELOW SHEER ON STBD HULL SIDE ADJACENT TO HEAD AREA
PROPANE BIN VENT	ON TRANSOM, UPPER STBD CORNER
BILGE PUMP	PORT COCKPIT COAMING
BILGE PUMP PICKUP B	ELOW DUST BIN
BILGE PUMP DISCHARGE	ON TRANSOM, LOWER STBD CORNER

## INTRODUCTION

## SECTION 1

## 1.1 INTRODUCTION

## 1.1

This manual is intended to acquaint you with the various features of your Pearson yacht and to provide information related to the care and upkeep of the yacht and its equipment. The manual supplements the literature supplied by the manufacturers of the systems and equipment installed in the yacht, and wherever practicable refers to this literature. It is recommended that the literature supplied by manufacturers be retained and the instructions therein followed.

## 1.2 FORMAT

The manual is divided into four basic sections.

Section 1, this section, contains a brief description of the contents, format of the manual, and the warranty. The warranty information included on the following page should be read carefully. This information, along with the warranty and parts information supplied by manufacturers of the system installed, will help maintain the yacht and all of its systems.

Section 2 of the manual covers the procedures that should be followed when commissioning the yacht. It includes the procedures that should be followed by the dealer at time of commissioning, as well as those items (such as safety equipment) that are the owner's responsibility. This section of the manual should also prove useful in subsequent recommissionings after periods of layup.

Section 3, 4, 5, 6, and 7 of the manual describes the various systems used on the yacht. Reference is made to manufacturers' instructions such as the engine manual and additional information is supplied whenever installations vary from the general conditions assumed in the manufacturers' instructions.

Section 8 provides a maintenance summary covering the procedures that should be followed to maintain the beauty and serviceability of the yacht. There are three sections: routine maintenance, laying-up procedures, and fitting-out procedures. Whenever feasible, reference is made to the appropriate manufacturer's literature.

## 1.3 WARRANTY

PEARSON YACHTS are carefully inspected and tested prior to shipment from our factory.

Because of this attention to quality control, our warranty is one of the most effective in the industry.

More important, however, is the knowledge and cooperation you as the owner, and we as the manufacturer, receive from the PEARSON Dealer Organization.

Your warranty is included in your file of ship's papers. Be sure to follow the instructions on filling out and forwarding. you can rest assured that our policy towards your warranty will result in your satisfaction.

## IMPORTANT NOTICE

UNDER NO CIRCUMSTANCES WILL PEARSON YACHTS WARRANTY A HYDRAULIC ADJUSTER PURCHASED FROM A SOURCE OTHER THAN PEARSON YACHTS. IF THE ADJUSTER IS INSTALLED BY PEARSON DURING THE CONSTRUCTION OF THE YACHT, A WARRANTY COVERING THE INSTALLATION WILL BE SUPPLIED BY PEARSON. SHOULD THE ADJUSTER BE PURCHASED ON A PARTS ORDER AND BE DEALER INSTALLED, THE DEALER WILL GUARANTEE THE INSTALLATION. THE ADJUSTER ITSELF CARRIES ITS OWN MANUFACTURER'S WARRANTY.

## 1.4 RESPONSIBILITY OF THE OWNER

1. Your prompt return of the warranty will help us ensure continued satisfaction. Your dealer will provide you with the required information and will co-sign the warranty. Please return the manufacturer's copy within thirty (30) days after taking delivery of your new boat.
  
2. Thoroughly check your Ship's Papers file to ensure that all instructions furnished with accessories are included.
  
3. Your Pearson dealer will competently handle any service problems that may arise. It is essential that you contact him for all warranty matters.
  
4. When it is necessary to contact Pearson, please address your letters as follows indicating your boat and hull number:

PEARSON YACHTS

WEST SHORE ROAD

PORTSMOUTH, RI 02871

Attn: Customer Service Department

## COMMISSIONING

## SECTION 2

## 2.1 INTRODUCTION

2.1.1 The first commissioning of a yacht is essentially the start of the yacht's life, and the importance of proper commissioning procedures at this time cannot be overestimated. The commissioning procedure will be performed by dealer personnel and requires no owner participation. Therefore, the owner need only to concern himself with items such as safety equipment which is considered to be his responsibility. Items of owner responsibility are further delineated in paragraph 2.4 of this section.

2.1.2 Complete lists of the pre-launch and post-launch checks employed during commissioning are provided in this section for those owners interested in understanding the decommissioning procedure, as well as for future use in any recommissionings that may be required after periods of wet or dry storage. The lists assume performance by persons cognizant of the procedures that are required, and do not attempt to provide step-by-step instructions. Detailed procedures are available in section 3 of this manual and other manufacturers' instructions that are provided with the yacht.

2.1.3 The factory installed equipment, and items of owner responsibility that require attention during commissioning are included in the list with the items marked with an asterisk (~), and the items involving owner responsibility marked with a double asterisk (11\*).

## 2.2 PRE-LAUNCH CHECKS

## 2.2.1 Hull Inspection.

Check topsides, decks, and all interior spaces for cleanliness and proper finish. Make certain that all foreign matter has been removed from the bilge areas, and check the following specific items:

\_\_\_\_\_ All thru-hull valves lubricated and closed, all hose clamps tight.

Propeller nuts and cotter pin properly made up.  
Steering gear and rudder operational.

\_\_\_\_\_ Strut bearing in place and secured.

\* \* Anti-fouling bottom paint applied.

## 2.2.2 Machinery Inspection.

Make an overall inspection of the machinery spaces. Ensure that they are free of loose material that might interfere with machinery operation, and then check the following items:

Engine installation work completed.

Engine oil, transmission fluid, and coolant levels satisfactory.

\_\_\_ All electrical switches OFF.

\_\_\_ Batteries fully charged, tied down, connected; electrolyte at proper level.

\* Installation of all equipment completed.

\_\_\_ All fuel and \*LPG valves CLOSED.  
Adequate amount of fuel in tank.

## 2.2.3 Before Mast is Stepped.

WARNING!! MOVE YOUR BOAT TO A POSITION THAT IS CLEAR OF OVERHEAD WIRES OR OBSTRUCTIONS. ELECTROCUTION MAY RESULT FROM CONTACT WITH ANY OVERHEAD WIRES! I

Check the following items:

Shrouds, stays, spreaders, installed and properly secured to mast. Check wire rigging for kinks or defects.

\* Masthead lights, spreader lights, and mast-mounted instrument units operational.

\* VHF antenna installed.

\_\_\_ All chafe points on mast properly taped.

## 2.2.4 Equipment On Board.

Check the following items:

\_\_\_ Winch handles, emergency tiller, and bilge pump handles.

Ground tackle.

Dock lines and fenders.

\*\*

\*\*

\*\* Safety equipment:  
 pfd's (life preservers)  
 throwable horseshoe or ring buoy  
 horn  
 shipls bell  
 emergency signals (flares, etc.)  
 fire extinguishers.  
 Medical kit.

\*\* Spare parts and tool kit.

## 2.3 POST-LAUNCH CHECKS.

### 2.3.1 Hull Inspection.

Make an overall inspection of the hull interior. Check bilge areas for evidence of major leaks near thru-hulls, and then make the following specific checks:

Open all thru-hull seacocks. Check each valve and associated hoses, couplings, etc.

\_\_\_\_\_ Check propeller shaft packing gland for nominal adjustment. Unless major leaking is observed, defer adjustment until paragraph 2.3.3.

\_\_\_\_\_ After the boat is rigged check shaft alignment, align if necessary, connect couplings. (See Fig. 4.~)

### 2.3.2 Electrical Inspection.

Make the following checks:

\_\_\_\_\_ Check the 12 volt supply at the electrical panel with the battery switch in the #1, #2, and ALL positions.

\_\_\_\_\_ Make an operational check of all DC circuits connected to the electrical panel.

\_\_\_\_\_ Connect the shore power cable, check the polarity indicator, close the main breaker, and make an operational check of the following items if installed.

120 volt receptacles  
 Hot water heater  
 Converter  
 Other AC equipment



### 2.3.3 Machinery Inspection.

\_\_\_\_\_ Secure the yacht to a pier or dock with bow, stern, and spring lines and operate the engine at low speeds in neutral, forward, and reverse. Check:

throttle and shift controls

engine operation

charging current

water temperature See engine owner's manual for operating temperature range.

oil pressure (see engine manual).

\_\_\_\_\_ Check the fuel system for leakage.

\_\_\_\_\_ Recheck the shaft packing gland for proper adjustment. Adjust if necessary. (See Paragraph 4.6.1)

\_\_\_\_\_ Install and check the operation of the emergency tiller.

### 2.3.4 Rigging And Sails.

Check the following after mast is in place:

\_\_\_\_\_ All standing rigging complete and in place, dockside tuning completed. (See paragraph 3.3)

\_\_\_\_\_ All cotter pins in place and taped.

Running rigging in place.

\_\_\_\_\_ Sails hoisted to check fit.

### 2.3.5 Fresh Water System.

Check the following:

\_\_\_\_\_ Water tanks full, no leaks at tank or fittings.

\* Pressure water system operational.

\_\_\_\_\_ Sinks and drains operational.

~ Hot water system operational.

\* Shower operational.

\* Sump pump operational.

Bilge pump operational.

### 2.3.6 Head System.

Check the following:

Head, holding tank, or other Marine Sanitation Devices operational.

- \_\_\_\_\_ Head intake and discharge hoses for leaks.
- \_\_\_\_\_ Y-valve and discharge plumbing.

### 2.3.7 Galley.

Check the following:

Propane valve, tank, and gauge functioning properly.  
(See Fig. 7.3)

Galley stove operational.

## 2.4 OWNER RESPONSIBILITIES.

For maximum enjoyment of your Pearson, due regard must be given to proper safety and maintenance procedures. The following is a partial list of items that are the responsibility of the owner:

Insure that your boat is operated according to the U.S. Coast Guard Regulations as outlined in the '1Federal Requirements For Recreational Boats'1. A copy of this pamphlet is included in your owner's manual and you should familiarize yourself with all operating requirements.

Prepare yourself for any situation before going out on the water. Follow the instructions provided in the sections of this owner's manual, the individual supplier instruction manuals, and all applicable U.S. Coast Guard and other regulations.

If you are not an experienced sailor, you should attend an accredited sailing school.

Before leaving the dock: be sure that all your equipment is in working order, that you are aware of the weather conditions, and that someone ashore is familiar with your destination or float plan.

### 2.4.1 Mandatory Coast Guard Safety Equipment.

Many safety items are required for compliance with the U.S. Coast Guard regulations. Note that these regulations are subject to change. It is the owner's responsibility to be cognizant of current regulations as outlined in the "Federal Requirements for

Recreational Boats". Additional copies may be obtained by writing the Consumer Affairs Staff, U.S. Coast Guard Headquarters, Washington, D.C. 20953 or by calling 202-~72-23814.

Depending on the length, passenger capacity, and operating conditions, your boat must be equipped according to the current U.S.C.G. regulations. Be sure that you operate your boat with the necessary PFDs (life preservers), fire extinguishers, signaling devices, distress signals, navigation lights, etc. as referred to in the '1Federal Requirements for Recreational Boats".

#### 2.4.2 Recommended Safety Equipment.

Preparation is the key to safety on the water. As a minimum guide, we recommend that you outfit your boat with the following equipment:

a compass - that is properly adjusted to give the correct magnetic reading.

a large capacity bilge pump

updated nautical charts of your intended cruising area

boat hook

large waterproof flashlight with spare batteries.

3 fenders

docking lines - a good rule of thumb to follow dictates that your bow, stern, and spring be equal to the length of the boat. We recommend 1/2 inch dacron line for this purpose.

##### 2.4.2.1 Ground Tackle

Anchor and rode - the following suggestions are provided as a general guide and should be revised to suit the the areas in which the yacht is to be sailed and the personal preference of the owner:

TYPE ANCHQ~~	C:HATN	RODF
5H Lunch	61 x i/~"	150' x 3/8"
12H Working BBB GALV.		3 STRAND
20H Storm PROOF COIL		NYLON LINE
DANFORTH*		

DANFORTH ANCHORS are manufactured exclusively by Danforth, Div. of Eastern Co., 500 Riverside Industrial Parkway, Portland, Maine, 0Li103

- 2.4.2.2 medical kit - Every yacht should carry a first aid manual, and a medical kit tailored to the specific needs and capabilities of the owner. Any shipls store should carry a standard type medical kit. Items in the kit should include:

aspirin  
 over-the-counter motion sickness pills  
 adhesive strips and tape  
 ammonia inhalants  
 antiseptic wipes  
 antiseptic germicide ointment  
 sunscreen first aid/burn cream  
 zinc oxide ointment  
 gauze bandages  
 insect/bee sting relief wipes  
 sterile pads  
 cold packs for sprains  
 scissors  
 tweezers

- 2.4.2.3 tool kit - a basic kit should consist of:

wrenches - adjustable, open end, box, socket  
 hammers - large and small  
 knife - with-marlinspike  
 screwdrivers - large and small, standard and Phillips  
 pliers - regular, cutting and needle nose, vise grips  
 wire cutter - capable of cutting standing rigging  
 hacksaw - with spare blades

- 2.4.2.4 spare parts - a basic kit should consist of:

standing rigging repair materials such as cotter pins, tumbuckles, stainless wire, clevis pins  
 running rigging and sail repair material such as blocks, extra line, sail slides, duct tape.  
 assortment of stainless steel screws, nuts, bolts, and washers  
 hose clamps  
 electrical tape, wire, crimp on lugs  
 spare navigation light bulbs  
 lubricating supplies - WD-~O, silicone grease  
 check engine manual for spare parts, engine oil and transmission fluid recommendations  
 sail repair kit  
 chafe tape - white vinyl

- 2.4.3 Additional Safety Equipment.

A number of additional safety items are worthy of consideration. These range from safety harnesses to emergency beacons, life rafts, and survival suits. Their use depends upon the intended use of the yacht. We suggest you investigate the necessity of these items through discussion with your dealer.

#### 2.4.4 Dealer Responsibilities.

PEARSON YACHTS are sold through Authorized PEARSON YACHTS Dealers who have been chosen to represent the company because of their knowledge of yachts and their ability to provide you with the attention and service you deserve. As experts in their profession they can competently handle any service problem which may arise.

Your PEARSON YACHTS Dealer is responsible for providing you with a high level of service before and after you purchase your yacht. It is his responsibility to:

Inspect your yacht upon delivery for loss and damage which may occur in transit and process any claims against the transport company.

Prepare your boat for commissioning or assist you by providing the initial commissioning procedures.

Verify that all specifications selected at time of ordering in addition to all other equipment are received in accordance with the Pearson packing list.

Operate and check all mechanical systems under the conditions of actual usage.

Instruct you on the use of your yacht and its systems.

Provide the necessary assistance and service under the terms of the Limited Warranty on your yacht, including the processing of all claims with PEARSON YACHTS.

Whenever a problem arises please contact your PEARSON Dealer. If it is necessary to contact PEARSON YACHTS, please indicate your model and hull number. Address your letters as follows to:

PEARSON YACHTS  
WEST SHORE ROAD  
PORTSMOUTH, R.I. 028'1  
attn: Customer Service Department

YACHT SYSTEMS - SPARS AND RIGGING  
SECTION 3

3.1 MAST.

3.1.1 Familiarize yourself with the Masthead Assembly diagram. (Fig. 3.1.1)

3.1.2 Spreaders And Standing Rigging (Fig. 3.1.2)

The standing rigging consists of a single spreader system, with single upper and double lower shrouds secured to chainplates athwartship of the mast; a headstay to provide forward support for the mast as well as support for the headsail; and a backstay. (See Fig. 3.1.3).

3.2 BOOM

3.2.1 Follow the Continuous Line Reefing instructions (fig. 3.2.1)

3.3

DOCKSIDE TUNING

Your Pearson is delivered in as near ready - to sail condition as possible with all basic tuning completed at time of commissioning. However, a basic tuning procedure has been included in this section to assist the owner in the future.

3.3.1 Before Mast Is Stepped (Fig. 3.3.1)

Make certain that the headstay, backstay, topping lift, upper and lower shrouds are connected to the mast. Note that toggles must be used when connecting the stays to the mast. Make certain that the headstay also has a toggle at the lower end.

Adjust all turnbuckles to their extended position to facilitate attachment when the mast is stepped. Make certain that each turnbuckle is installed with the clockwise threads in what will be the down position when the turnbuckle is in place.

Check the operation of any masthead-mounted instrumentation as well as masthead, anchor, or spreader lights. If a flag halyard is desired, it should be rigged now. VHS antenna should be installed.

Ensure that all shrouds and stays are properly secured to the mast with all cotter pins and chafe points taped.

On centerboard models, prepare the centerboard pennant to be passed through the hole at the base of the mast as the mast is being stepped on deck.

INCORRECT WAY TO ADJUST THE TIE ROD.

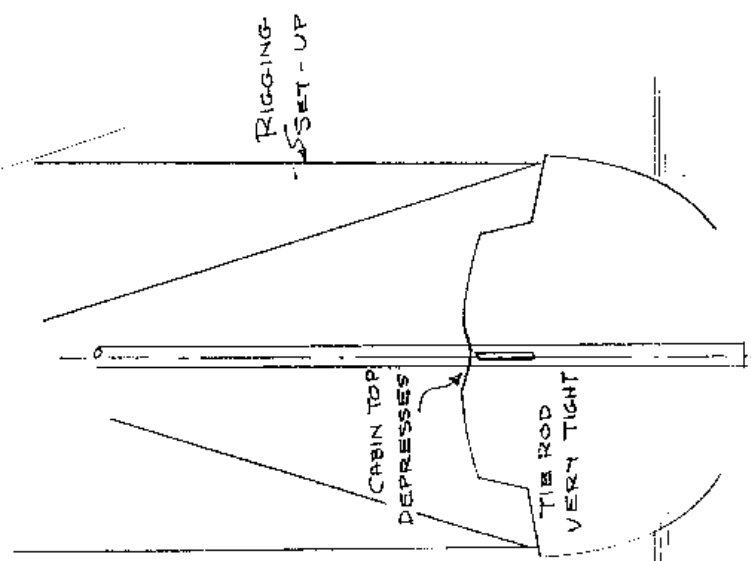
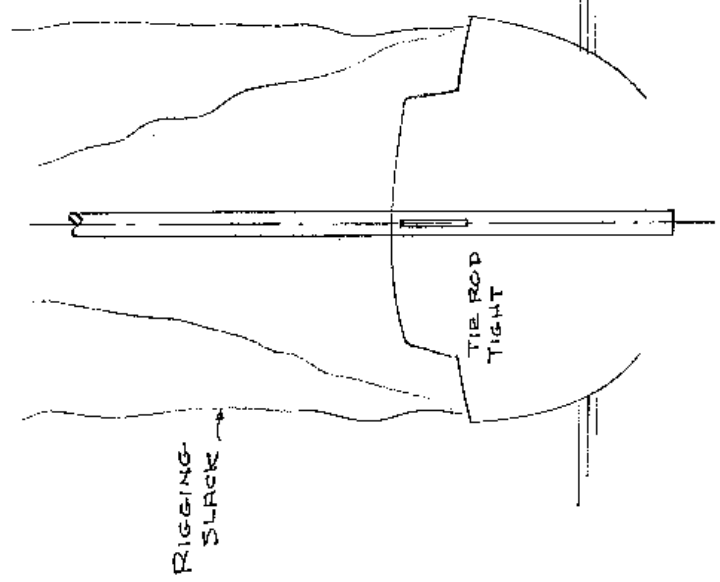

IF TIE ROD IS TIGHTENED BEFORE THE RIG IS SET-UP

THEN WHEN RIG IS TIGHTENED THE CABIN TOP WILL BE DEPRESSED, DOORS MAY BIND, ETC

WHS. 12 JUL 62

CORRECT PROCEDURE FOR SETTING UP THE TIE ROD.

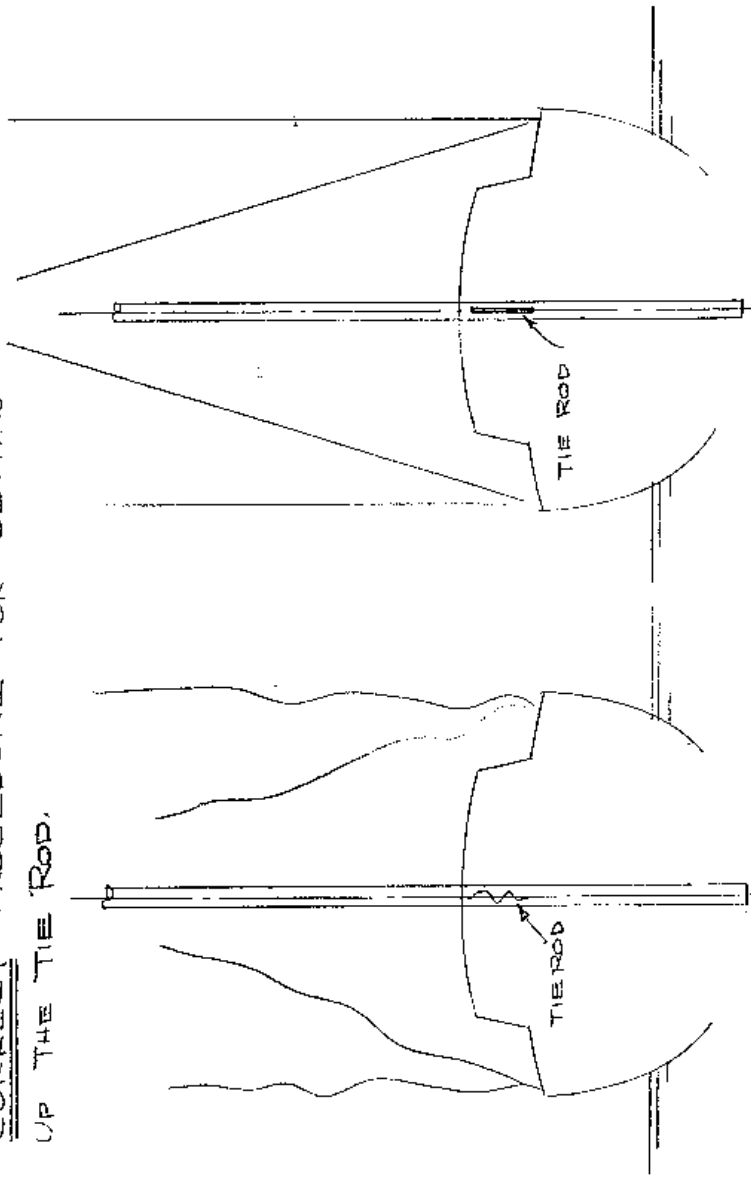

- (1.) STEP THE MAST, PIN THE RIGGING.  
LEAVE THE ROD SLACK
- (2.) SET UP THE RIGGING.  
THEN HAND TIGHTEN THE ROD

WHIS / 18 JUL / 68.



TYPICAL MASTHEAD INSTALLATION  
ISOMAT SPAR

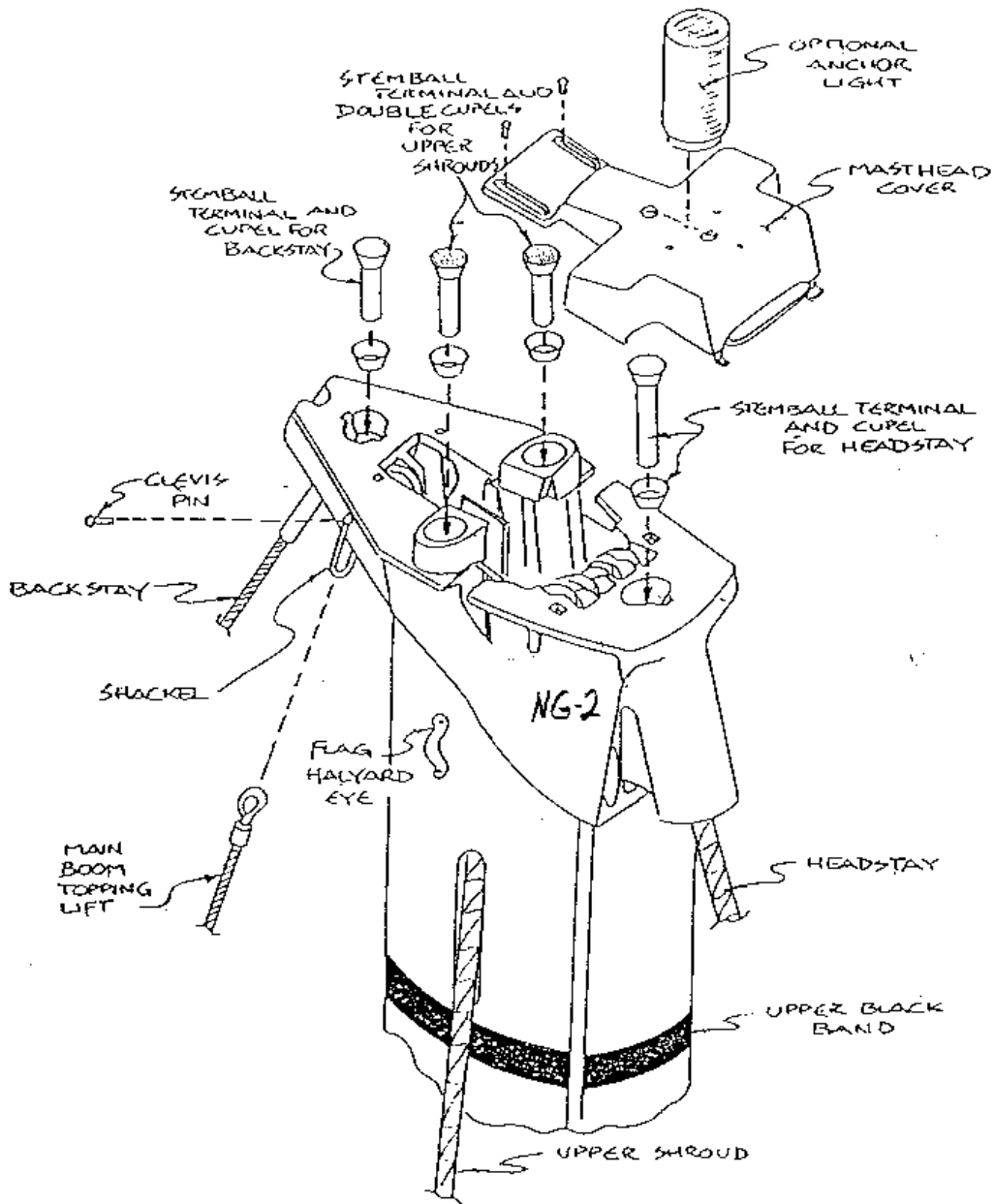

3.1.1

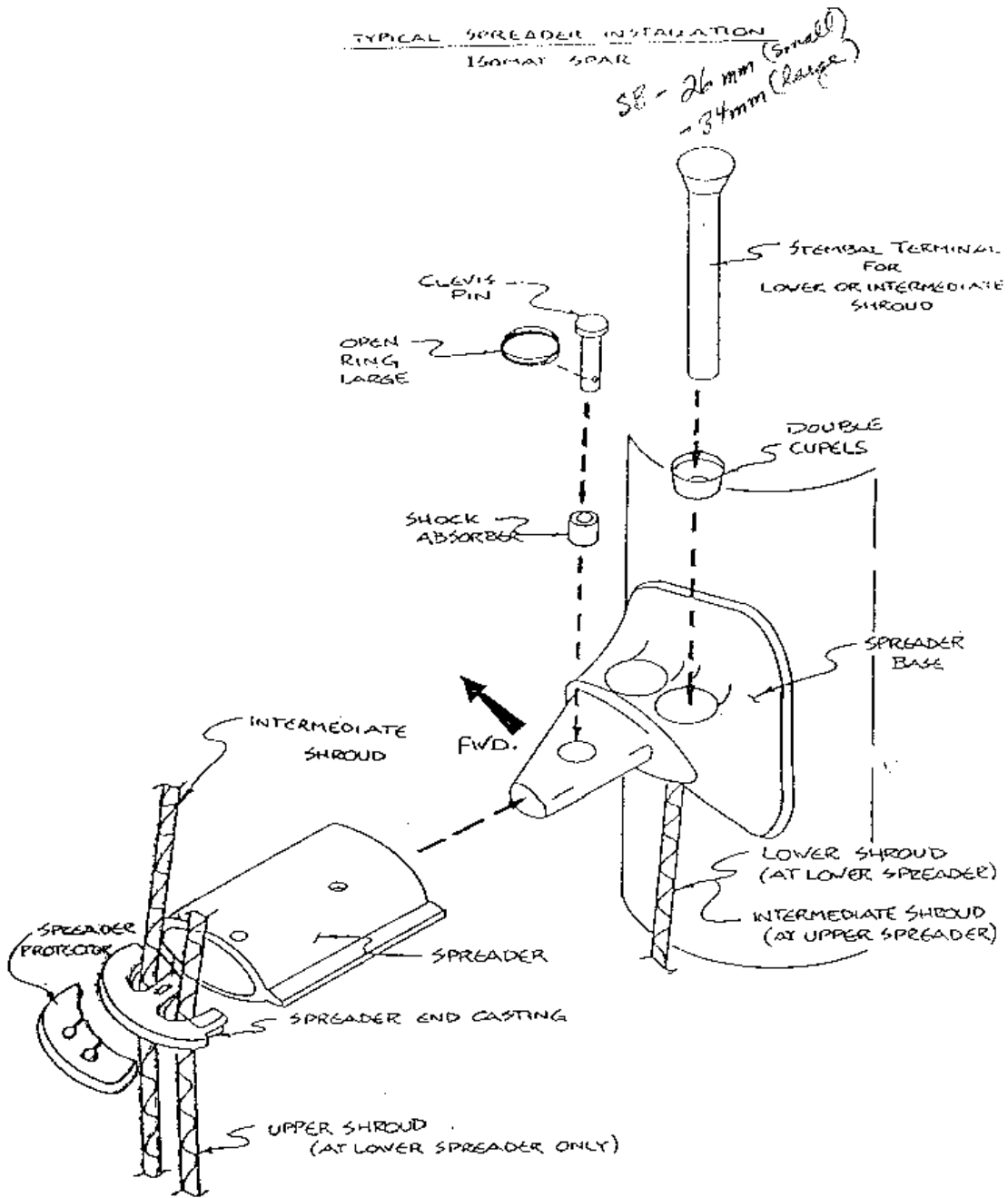

NOTE: LOWER END OF SHROUD TO BE SLIPPED THRU CUPEL AND SPREADER BASE

Fig. 3.1.2

PEARSON 31 RIGGING SCHEMATIC

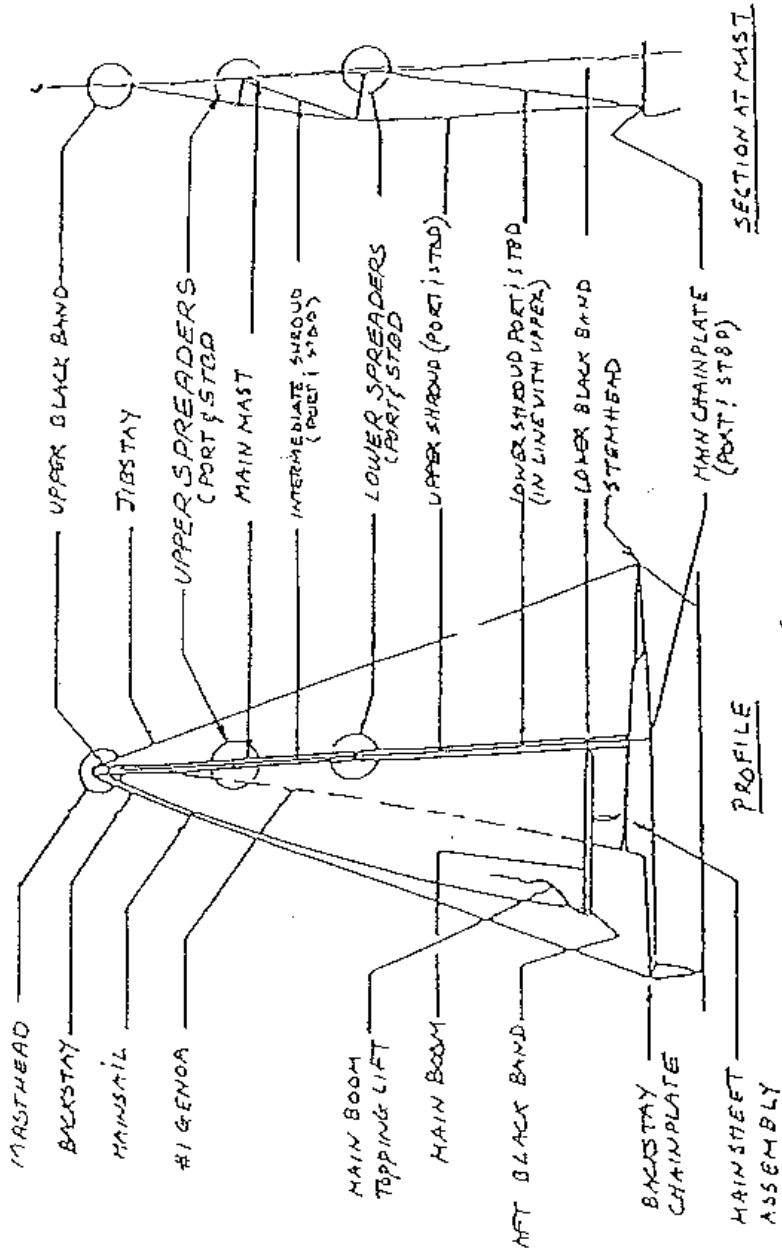

3.13

CONTINUOUS LINE REEFING

INSTRUCTIONS FOR USE

1. Ease the mainsheet to luff the main.
2. Release the halyard to a length equal to the distance from the gooseneck to the desired reef point. (Mark these points for quick reference.)
3. Pull on the reef line led aft until both the clew and tack cringles are drawn down tightly and proper out-haul tension is achieved in the foot.
4. Retension the halyard.
5. Retrim the mainsail as desired.

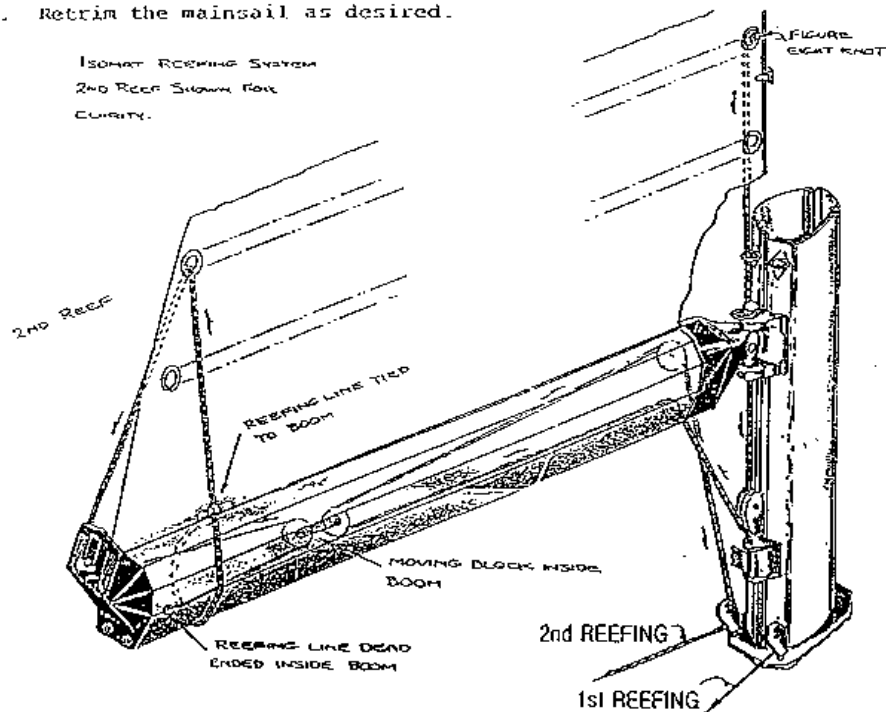

**CUNNINGHAM AND FLATTENING REEF ADJUSTMENTS:**

1. To apply cunningham to the luff of the mainsail, run the luff end of the first reef line to the attachment grommet for the cunningham and dead end with a figure-eight knot. Winch in the tail end of the first reef line until the desired tension is produced. Once this is accomplished, set the stopper handle down to secure this position.
2. To install a flattening reef, run the first reef line to the cringle on the leach, set up for a flattener, and back to the boom as you would a typical jiffy reef. With the luff end of the reef line dead ended, with a figure-eight knot through the mast fairlead, winch in the tail end of the reef line until the desired tension is produced. Once this is accomplished, set the stopper handle down to secure this position.

Fig. 3.2.1

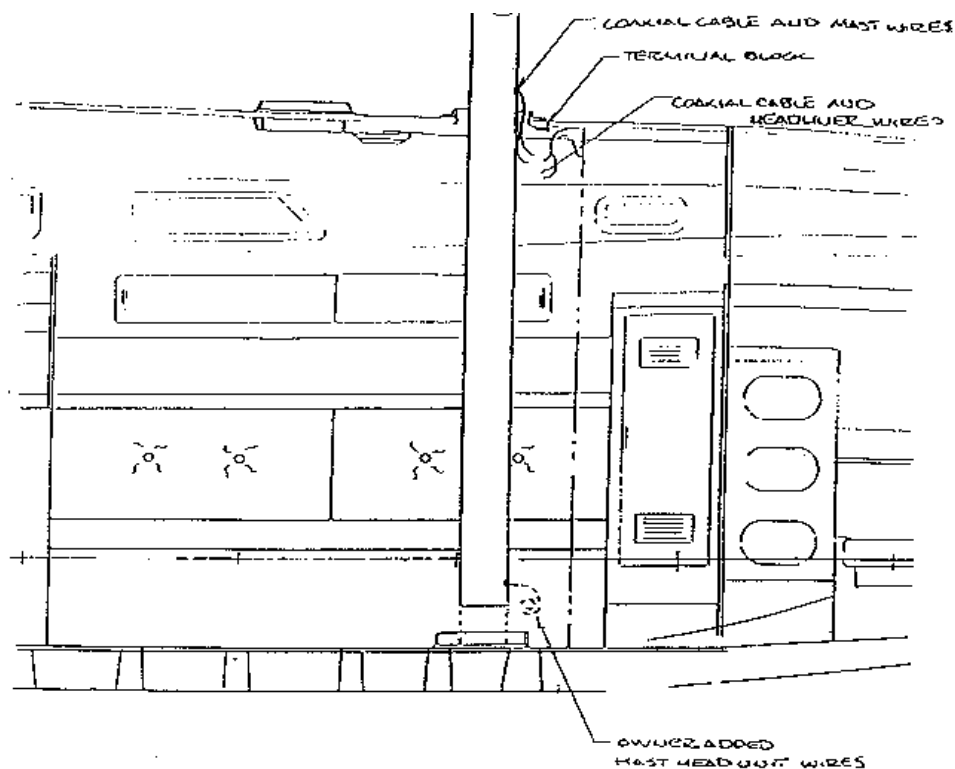

#### MAST INSTALLATION

1. Before stepping the mast, slip the mast boot assembly onto the mast and position it at a point on the mast where it will not interfere with installing the mast into the boat. Make certain that it is oriented properly (top side up). An error here would require removal of the mast. Temporarily secure the boot assembly at this position.
2. Lower the mast to within 12"-15" of the mast collar.
3. Feed coaxial cable and mast wires through the deck.
4. Lower mast to step. Avoid pinching wires against the deck cutout. Also avoid striking the interior joinerwork with the butt end of mast.
5. Block the mast in place with teak blocks on the aft and forward side of the mast step. Place two (2) blocks forward and three (3) blocks aft in the step.
6. Center mast in deck collar and secure in place with wooden wedges.
7. Connect wire ends from the mast to corresponding ends from the headliner.
8. Wires for owner installed masthead units can be terminated in the trap below the starboard settee wing and led aft along the starboard side.
9. Install the tie rod assembly. See Fig. 3.3.2.

Fig. 3.3.1

### 3.14 UNDERWAY TUNING

With the jib and main set , under moderate wind conditions, sail to windward on one tack. Sight up the mast to check for straightness. The mast should not bend to leeward or to windward. If the need for adjustment is indicated, make the proper adjustment to the upper or lower shrouds while observing the following rules.

If a take-up adjustment is indicated, go on the opposite tack so that the shroud is more easily adjusted.

Always tack both directions to ensure straightness of the mast.

If at all possible, avoid adjusting the upper shrouds since this will affect the mast perpendicularity.

#### 3.4.1 Weather Helm

The rake of the mast will affect the amount of "weather Helm"! . Weather helm increases as the mast is raked aft and decreases as the rake is reduced. Final adjustments to rake should provide a slight weather helm in moderate wind conditions.

### 3.5

#### CARE AND MAINTENANCE

The sails, spars, rigging, and associated hardware constitute the main propulsion system for the yacht and, as such, deserve a measure of attention. Proper care of sails is of utmost importance if expensive replacements are to be avoided and the recommendations of the sailmakers should be followed closely. The stainless steel standing rigging is virtually corrosion proof, and unless physically abused, should give many years of trouble free service. Running rigging when properly selected should also give good service, but being subject to constant wear as well as the deteriorating effect of sunlight, should be monitored on a continuing basis to avoid inopportune failures. Hardware such as winches, blocks, and travelers also need periodic attention if they are to remain in first-class condition. The following comments are intended as general guidelines. Additional procedures can be added to suit the intended use of the yacht.

#### 3.5.1 Rigging and Lines.

Clean wire rope, swage fittings, and toggles with fresh water and, if desired, a water soluble detergent. Use a stiff brush or nylon scrubbing pads. Do not use steel wool or cleansers containing chlorine.

When storing shrouds, stays, or halyards, wash with fresh water, dry with a clean cloth, and store in a dry location away from chemicals, oil, or other contaminants. Avoid crushing, kinking, or coiling too tightly.

### 3.3.2 While Stepping The Mast (Fig. 3.3.1)

#### 3.3.3 After Mast Is Stepped.

##### 3.3.3.1 rake adjustment

Hang a weight such as a hammer or wrench from the main halyard just below the gooseneck level. The fore and aft distance between the halyard and the mast at the gooseneck is the amount of rake.

NOTE: YOUR PEARSON IS DESIGNED TO HAVE THE MAST RAKED AFT. SEE SAIL PLAN FOR SPECIFIC INFORMATION. THIS MAY BE VARIED TO SATISFY THE PREFERENCE OF SAILMAKERS<sup>3</sup> BUT FORWARD RAKE SHOULD BE AVOIDED.

Adjust the headstay and the backstay turnbuckles (let off on one<sup>3</sup> take up on the other) until the desired rake is achieved. Make certain that the lower shrouds and intermediate shrouds are slack enough not to interfere with this adjustment.

Pin the headstay and backstay turnbuckles.

##### 3.3.3.2 side-to-side perpendicularity.

Ensure that the lower shrouds and intermediate shrouds are slack enough so as not to interfere with the follow adjustments.

Lead the shackle end of the main halyard to an identifiable point on the rail or chainplate. Adjust the halyard tension so that the shackle just touches this point, and then cleat the halyard.

Lead the halyard to the same location on the opposite side of the deck, and check to see if the shackle touches the same point with the same tension. If this is not the case, let off on one upper shroud turnbuckle and take up on the other to get the desired result.

With the mast centered transversely, tighten both upper shrouds uniformly, one full turn on one side, then one full turn on the other. Repeat until the turnbuckles become properly tight. Pin and tape the upper shroud turnbuckles.

Tighten the lower shroud turnbuckles to a hand-tight condition, then sight up the mast to check for straightness. Make appropriate adjustments to the lower shroud turnbuckles if this is not the case, ie. if the mast is not straight. Be sure to make equal and corresponding adjustments on each set of turnbuckles (a one-turn take-up on the port lower shroud should be followed by a one-turn easing on the starboard shroud, etc.).

Pin and tape the lower shroud turnbuckles. Tape any remaining pins.

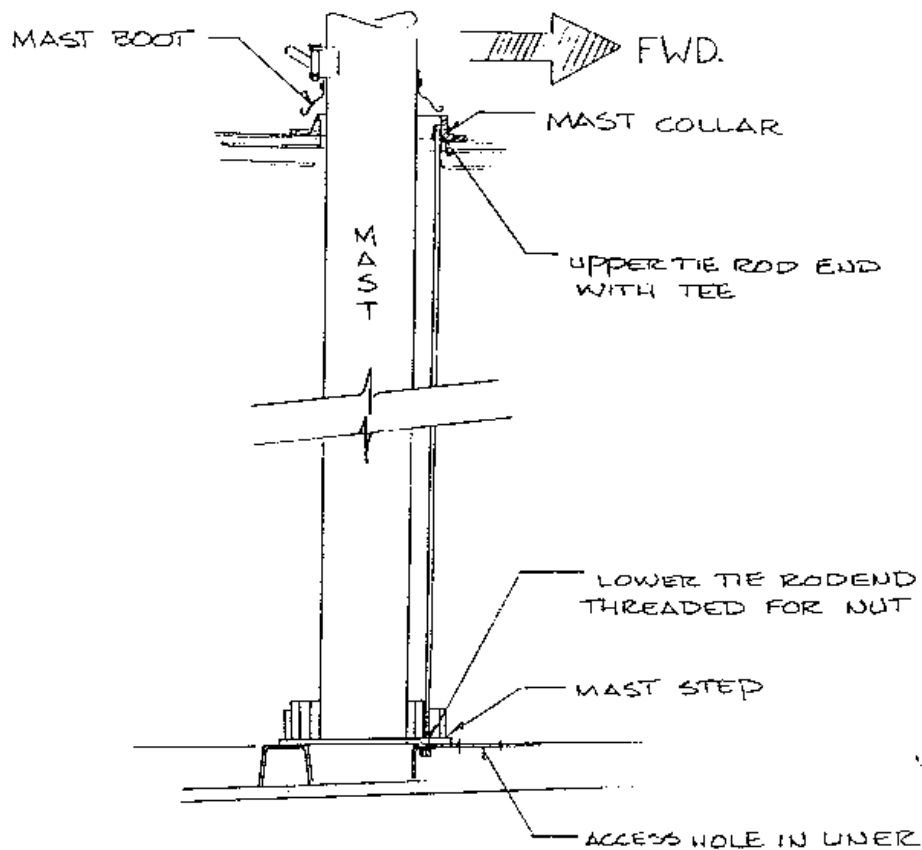

#### TIE ROD INSTALLATION

1. After stepping the mast and prior to fixing the mast boot in place, run the tie rod with the tee connector end up through the mast collar on the forward side of the mast.
2. Run the lower threaded end of the tie rod down through the hole in the forward end of the mast step; at the same time inserting the tee connector on the other end into the slot in the mast collar.
3. Through the access hole in the liner forward of the mast step, insert a washer and locknut. Thread the nut onto the tie rod end sufficiently to secure the tie rod in place.

Fig. 3.3.2



Synthetic rope will deteriorate with prolonged exposure to salt and sun. Rinsing with fresh water is beneficial. An occasional soaking in warm soapy water is also advisable. Rinse and dry thoroughly before stowing.

NOTE: AN EXCELLENT WAY TO CLEAN SYNTHETIC ROPE IS TO RUN IT THROUGH A WASHING MACHINE SET ON A WARM CYCLE. FOR THE WELFARE OF BOTH THE SYNTHETIC ROPE AND THE WASHING MACHINE, MAKE CERTAIN IF THIS IS DONE, THAT THE CONSTRUCTION OF THE WASHING MACHINE IS SUCH THAT IT IS NOT POSSIBLE FOR THE ROPE TO SLIP BEHIND THE BASKET.

A regular on-going check should be made on all standing and running rigging with emphasis on the following:

Evidence of fraying, chafing, kinking, or other signs of wear.

Cotter pins secure and taped.

Evidence of stress or cracking around swaged terminals.

CAUTION! DO NOT WRAP WIRE ROPE WITH TAPE, PLASTIC, OR OTHER ADHESIVE MATERIAL. SUCH A COVERING CAN EXCLUDE OXYGEN NEEDED TO MAINTAIN A PASSIVE SURFACE ON THE WIRE. THIS CAN ADVANCE CORROSIVE OR DETERIORATING ACTION.

#### 3.5.2 Winches.

All winches should be inspected, cleaned and lubricated in accordance with the instructions in the servicing booklet for the winches that is provided at commissioning.

YACHT ~SYSTEMS -POWER  
SECTION 4

## 4.1

## GENERAL DESCRIPTION - DIESEL ENGINE

The heart of the power system installed on your Pearson is a diesel engine. Detailed descriptions of the features of the engine, along with complete operating and maintenance procedures, are provided in the engine manual supplied in the ships papers.

See Fig. 4.2 for the power system.

## 4.2

## DIESEL OPERATION

Operation of the diesel engine includes preparation for starting, running, stopping, and securing the power system after use. The following paragraphs are included as a general guide, with complete procedures being more thoroughly covered in the engine manual.

## 4.2.1 Additional Controls

In addition to the control panel, the following controls are associated with engine operation.

Battery Switch - Although properly a part of the electrical system, this switch located in the main cabin under the chart table must be energized.

Throttle and Shift Controls - Throttle and gear shift controls are located at the helm station.

Decompression Lever - It is located on the engine to assist in cold starts or when the battery is low. See the engine manual.

CAUTION! EXCEPT IN EMERGENCIES SUCH AS ENGINE RUNAWAY OR THROTTLE DAMAGE, DO NOT USE THE DECOMPRESSION LEVER TO STOP THE ENGINE. THIS CAN CAUSE SERIOUS DAMAGE TO THE EXHAUST VALVES

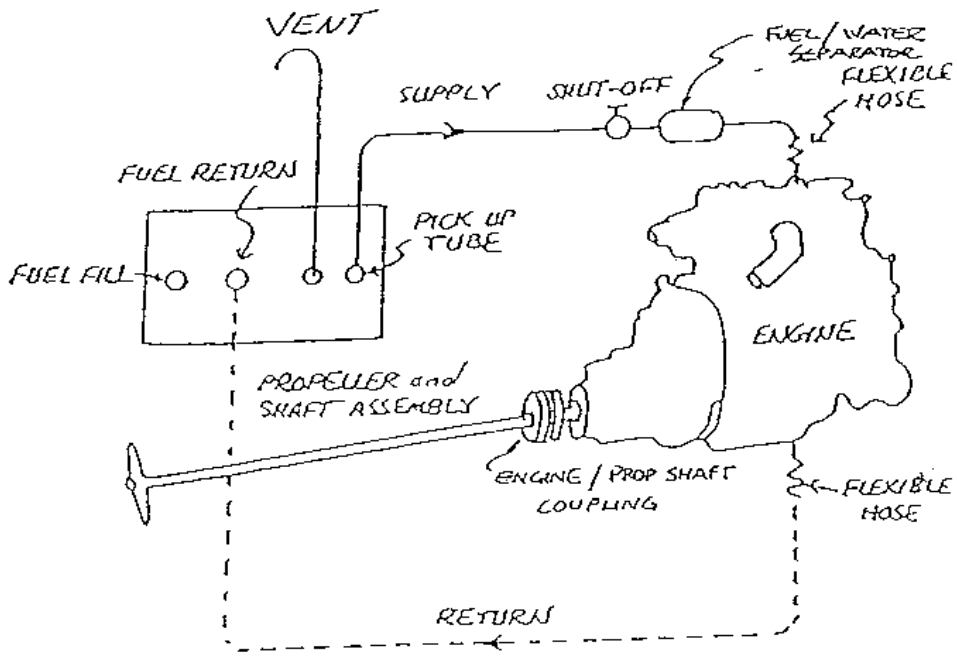

POWER SYSTEM SCHEMATIC

4.2

#### 4.2.2 Before Starting

While this is a practice often neglected on an auxiliary, a power system should always be inspected before starting. At the very least, an inspection should be made at the start of a cruise, and before starting the engine after an extended period under sail. The following items should receive particular attention:

Visually inspect the engine space and the engine. Look for fuel and/or water leaks, and any other problems that might preclude starting.

Ventilate engine compartment by running the blower.

**WARNING! ALTHOUGH LESS VOLATILE AND FAR SAFER THAN GASOLINE, DIESEL FUEL IS FLAMMABLE, AND A FUEL LEAK CAN CAUSE A SERIOUS FIRE!**

Check fresh water level in manifold.

Ensure that the engine seacock is open.

Ensure that fuel valve is open.

Check fuel supply.

Check engine and V-drive oil levels.

Ensure that the battery switch is 110N11.

Ensure that the transmission control is in "NEUTRAL".

#### 4.2.3 STARTING

Normal starts, cold weather starts, starting procedures after a long shutdown, and other operational suggestions are contained in the engine manual. Some additional suggestions are listed below:

**CAUTION! DO NOT OPERATE STARTER FOR MORE THAN 10 SECONDS AT A TIME.**

Forward, Neutral, Reverse. When shifting from forward to reverse, or vice versa, the lever should be held in the neutral position for a moment before proceeding. Shifting should be performed with RPM reduced to idle.

#### 4.2.4 Stopping

To stop the engine:

Place throttle in the idle position.

Place transmission shift lever in neutral (center position).

Let engine idle for one (1) minute to allow it to cool down.

Pull stop cable out until the engine stops.

Push stop cable in.

Turn the key to the "OFF" position.

CAUTION! DO NOT SWITCH BATTERY SELECTOR UNTIL THE ENGINE HAS COME TO A COMPLETE STOP! THIS WILL PREVENT ALTERNATOR AND REGULATOR DAMAGE.

CAUTION! DO NOT USE DECOMPRESSION LEVER TO STOP ENGINE. THIS COULD SERIOUSLY DAMAGE EXHAUST VALVES.

CAUTION! IF YOU CLOSE THE FUEL AND SEA WATER VALVES AFTER STOPPING THE ENGINE, BE SURE TO RE-OPEN THEM BEFORE RESTARTING. FAILURE TO DO SO COULD CAUSE ENGINE TO OVERHEAT AND CAUSE DAMAGE TO THE PUMP IMPELLER OR CAUSE FUEL LINES TO BECOME AIR LOCKED.

#### 4.3 DIESEL.. .MAINTENANCE

Whether maintenance of the power system is to be performed by the owner or delegated to a mechanic, it is the owner who must first initiate any action that is to take place. He must either perform the maintenance or decide to call someone to do the job, and a working knowledge of the power system is essential in the first case, and desirable in the second. The engine manual is, of course, the prime source for engine information and should be consulted, preferably before the fact. The following paragraphs are included as a supplement to cover any required maintenance procedures that are not a part of the engine manual.

##### 4.3.1 Fuel Sanitation

The fact that a diesel engine does not require an ignition system can, and usually does, result in an engine that is far superior to a gasoline engine in regards to dependability. Whether this is actually the case depends greatly on the cleanliness of the fuel that is supplied to the engine since the close tolerances required by the engine's fuel delivery system make it extremely intolerant of any form of dirt or water contamination. The engine is supplied with primary or secondary filters that prevent contaminants from reaching the engine where they could cause damage, but a clogged filter, although providing this protection, can also stop an engine. Keeping the filters free of dirt and water is an obvious answer to this problem, and the cleaning schedules set forth in the engine manual will in most cases keep filters clean enough to prevent stoppage.

### 4.3.2 Bacterial Contamination

A factor that can cause additional problems is bacterial contamination of the diesel fuel. The bacteria involved need both water and fuel to exist, and if present, will thrive at the fuel/water interface in a fuel tank. As they multiply, they form more water and a filter-choking brown slime. Often their presence will not be known until rough weather churns up the fuel tank causing clogged filters at a most inopportune time.

Keeping water out of the fuel will, of course, prevent the problem entirely, and while every effort should be made toward this end, such as obtaining fuel from reputable dealers, it must be remembered that a certain amount of water due to normal condensation in the tank is to be expected.

### 4.3.3 Fuel Additives

Fuel additives or conditioners provide another means of combating this problem. These additives break the water down to a molecular level, dispersing it throughout the fuel and allowing it to pass harmlessly through the fuel system. Various brands of this product are available at marine supply stores. As with all products of this nature, the directions on the can should be read carefully.

## 4.4

### FUEL SYSTEM...GENERAL DESCRIPTION

The fuel system for your Pearson is illustrated in Fig. 4.2 and consists of one aluminum fuel tank, pick up tube, and return lines, a fuel/water separator as a primary fuel filter, and a secondary fuel filter on the engine.

## 4.5 FUEL SYSTEM... FUELING

While employment of a diesel engine results in a greatly reduced fuel hazard when compared to gasoline, it should be remembered that diesel fuel is flammable, and that the employment of good fueling practices are necessary. The following steps are provided as guidelines.

### 4.5.1 Before Fueling

Extinguish all smoking materials and check the fueling area for other sources of spark or flame. Remove if found.

Shut off the engine, and the electrical generator if one is aboard.

De-energize all electrical equipment.

Close all hatches and ports.

Ensure that a fire extinguisher is readily available.

Ensure that the proper (diesel, not gasoline) hose is about to be used.

WARNING! DO NOT FUEL DURING AN ELECTRICAL STORM. BESIDES THE OBVIOUS HAZARD OF LIGHTNING, THE POSSIBILITY OF STATIC DISCHARGE IS GREATLY INCREASED AT THE TIME.

#### 4.5.2 Fueling Procedure

Remove fill pipe cover and use dipstick and/or fuel gauge to determine fuel requirements in order to prevent overfilling.

WARNING! USE ONLY THE SPECIAL SPANNER WRENCH PROVIDED. DO NOT USE A HAMMER, SCREWDRIVER, OR OTHER TOOLS WHICH COULD CAUSE A SPARK OR DAMAGE THE COVER.

Place nozzle of fuel hose in the fill pipe.

WARNING! KEEP THE NOZZLE IN CONTACT WITH THE DECK PLATE RIM DURING FUELING TO AVOID THE POSSIBILITY OF A STATIC SPARK.

Fill slowly. Do not overfill. If it is not possible to see the meter on the fuel pump, the attendant or a crew member should call out the gallonage from the fuel dock.

CAUTION! FUEL VOLUME WILL INCREASE WITH AN INCREASE IN TEMPERATURE. FILLING THE TANK TO ONLY 95% OF CAPACITY WILL AVOID OVERFLOW PROBLEMS ON A HOT DAY.

#### 4.5.3 After Fueling

Replace cover, clean up any spilled fuel. If any rags, etc. were used for this purpose, dispose of them ashore.

Check below decks for presence of fumes or fuel leakage. Check bilge, engine space, and main cabin.

WARNING! IF FUMES OR EVIDENCE OF LEAKAGE IS FOUND, DETERMINE THE CAUSE, CORRECT IT, AND CLEAN UP ANY SPILLAGE BEFORE PROCEEDING.

Open all hatches and ports to ventilate the boat. Switch on battery.

The engine should be started only when it is certain that no potentially hazardous condition exists.

## 4.6 PROPELLER & SHAFT ASSEMBLY

### 4.6.1 Shaft Packing Gland

A properly adjusted shaft packing gland should drip slightly (from 14 to 8 drops per minute) with the engine on. Too loose an adjustment will allow too much water in the bilge, and engine operation will spray water from the shaft. Too tight an adjustment will rob the engine of power, and the lack of water lubrication in the packing gland can generate enough heat to damage the gland and/or score the propeller shaft.

NOTE: THE PACKING GLAND IS LOCATED BEHIND THE ENGINE AND IS ACCESSIBLE THROUGH THE QUARTERBERTH, OR THROUGH THE COCKPIT SEAT LOCKER.

#### 4.6.1.1 adjustment

Holding the packing nut with one wrench, use a second wrench to loosen the lock nut. Turn the lock nut far enough to keep it from interfering with the next adjustment (2 or 3 turns).

Tighten the packing nut to obtain 14 to 8 drops per minute.

NOTE: HAND TIGHTENING OF THE PACKING NUT IS OFTEN SUFFICIENT TO OBTAIN THIS ADJUSTMENT. IF THIS IS NOT THE CASE, AN ADDITIONAL 1/14 TO 1/2 TURN WITH THE WRENCH SHOULD PRODUCE THE DESIRED RESULT.

Hold the packing nut in place with one wrench, and use the second wrench to bring the locking nut securely against the packing nut.

CAUTION! MAKE CERTAIN THAT THE LOCKING NUT IS TIGHT. FAILURE TO DO THIS COULD ALLOW THE PACKING NUT TO BACK OFF WHEN THE ENGINE IS OPERATING.

Operate the engine at slow speeds in forward and reverse and use a light to check for excessive water at the packing nut. Shut off the engine and recheck packing nut for proper drip.

### 4.6.2 Shaft coupling (Fig. 14.6)

A careful alignment between engine and propeller shaft at the shaft coupling is essential if efficient and vibration free operation is to be attained. This alignment involves making adjustments to the engine mounts until the mating surfaces of the coupling are properly aligned and is one of the tasks that is performed during commissioning.

NOTE: THE SHAFT COUPLING IS LOCATED AT THE REAR OF THE ENGINE.



Once adjusted, the alignment is not likely to require readjustment unless it becomes necessary to move the engine, or to perform extensive work on the propeller shaft assembly. In cases such as this, it is recommended that an experienced marine mechanic perform the adjustment.

Since it may become necessary to disconnect and reconnect the coupling at one time or another (some people prefer to do this when the boat is hauled), and since this procedure, as well as the procedure for simply checking the alignment are not extensive, they have been included in the following paragraphs:

WARNING! ENSURE THAT THE ENGINE 'LOFF/ON" SWITCH IS OFF AND REMOVE THE KEY TO MAKE CERTAIN THAT THE ENGINE CANNOT BE STARTED DURING THE FOLLOWING PROCEDURES.

#### 4.6.2.1 Flexible coupling connector

Your shaft assembly includes a flexible coupling connector specified for your engine. This coupling connector is installed to further reduce vibration in the propulsion assembly in addition to the flexible engine mount. Together with a properly aligned engine and shaft these features will provide the smoothest and quietest running engine possible.

NOTE: THE FLEXIBLE COUPLING CONNECTOR WILL NOT ELIMINATE THE VIBRATION FROM A POORLY ALIGNED ENGINE.

#### 4.6.2.2 To disconnect coupling

Remove the connecting bolts from the shaft coupling, and move the two mating surfaces apart.

CAUTION! IF IT IS NECESSARY TO PRY THE COUPLING APART, USE CARE NOT TO SCAR THE TWO MATING SURFACES.

#### 4.6.2.3 To check alignment

Ensure that the two mating surfaces on the shaft coupling are clean.

Pull the shaft forward until the flange faces come gently into contact, and attempt to insert a .00~ feeler gauge between the faces. Do this at the 12, 3, 6, and 9 o'clock position on the flange.

Rotate the propeller shaft 180 degrees and repeat the step above.

If the feeler gauge can be inserted at any point on the flange, the engine and shaft in need of alignment. If this is the case, an experienced mechanic should perform the adjustment.

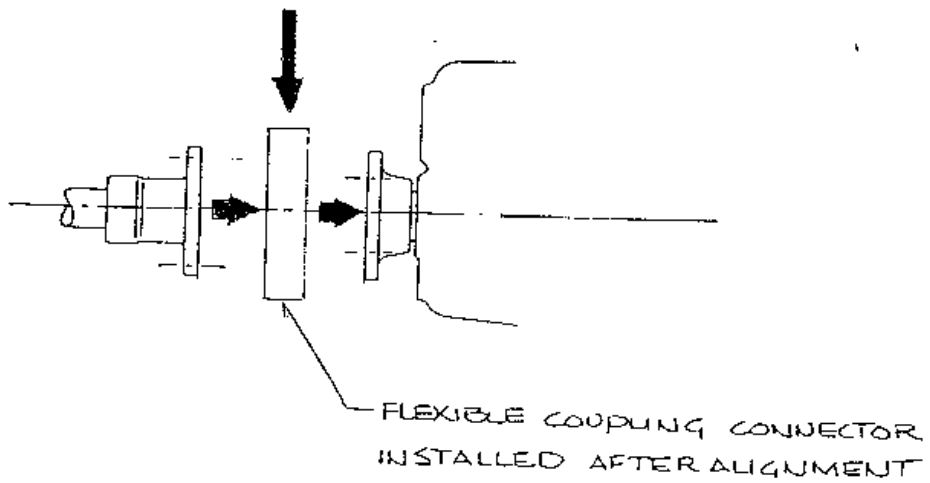
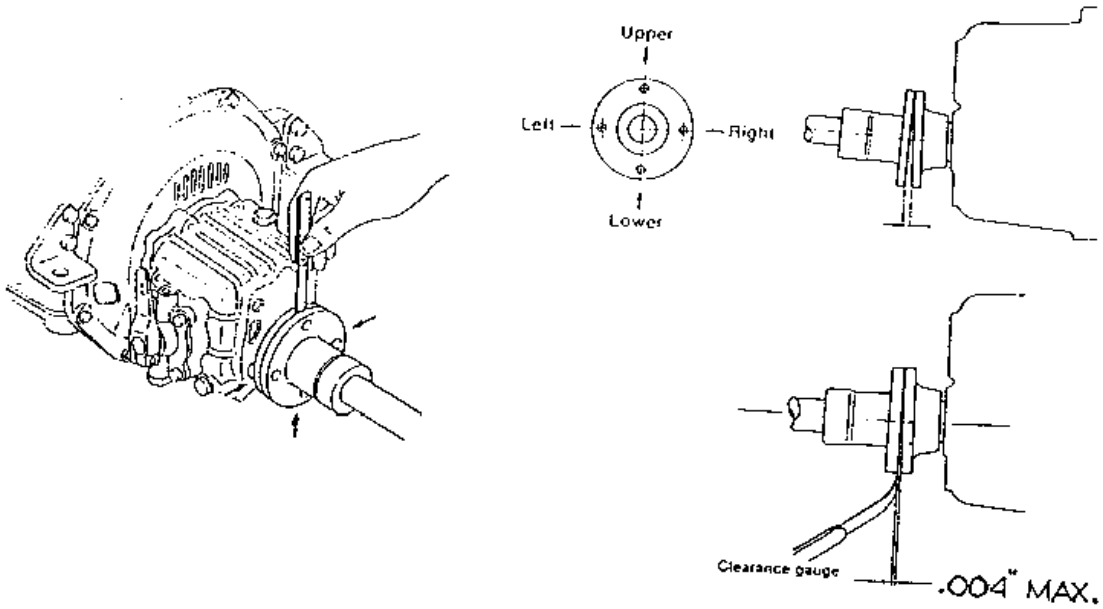

TYPICAL PROPELLER SHAFT ALIGNMENT

4.6

4.6.2.4 To reconnect coupling

Move the shaft flanges close enough to permit threading the bolts through the flanges. Thread all bolts finger tight.

Tighten all bolts in a uniform manner until they are all tight (approximately 40 ft. lbs.).

## 5.1 GENERAL DESCRIPTION

A 120 VAC electrical system has been installed on your Pearson. It consists of a 50 amp. shore connection, a circuit breaker panel, hot water heater and receptacles, range, microwave, lights, VCP/Tv, converter, refrigerator. See Fig. 5.1.

It is a single-phase 120-volt system with shore-grounded (white) neutral conductor and grounding (green) conductor.

This system directly utilizes the shore-grounded (white) and undergrounded conductors, together with both the shore-grounding (green) conductor and the boat's ground to keep the exposed non-current-carrying parts of the system at ground potential.

The grounded (white) and ungrounded shore current-carrying conductors are connected from the shore-power cable and the boat's AC circuit or system through an overcurrent protection device which simultaneously opens both current-carrying conductors. The boat's AC electrical system includes multiple circuits, each such circuit is protected by a simultaneous-trip circuit breaker.

The shore-grounding (green) conductor is connected from the shore-power cable and the boat's power inlet directly to all non-current-carrying parts of the AC electrical system and to the engine negative terminal.

Although this arrangement may lead to a slight increase in the electrolysis of underwater metal parts this is more than offset by the increased protection against accidental, perhaps deadly shock from a faulty 110 volt system in or around the boat.

A dual battery 12 volt DC electrical system has been installed on your Pearson. A master ON/OFF switch makes it possible to disconnect the battery from the entire electrical circuit or choose either battery, and a switch/circuit breaker panel supplies the yacht's electrical loads. The electrical circuit is shown in the schematic in Fig. 5.2 and in greater detail in the engine manual. All major metal parts of the hull, except for electrically insulated thru-hulls, are all bonded to a common point for galvanic stability. See Fig. 5.2.

PEARSON YACHTS CORP.  
12V DC SYSTEM

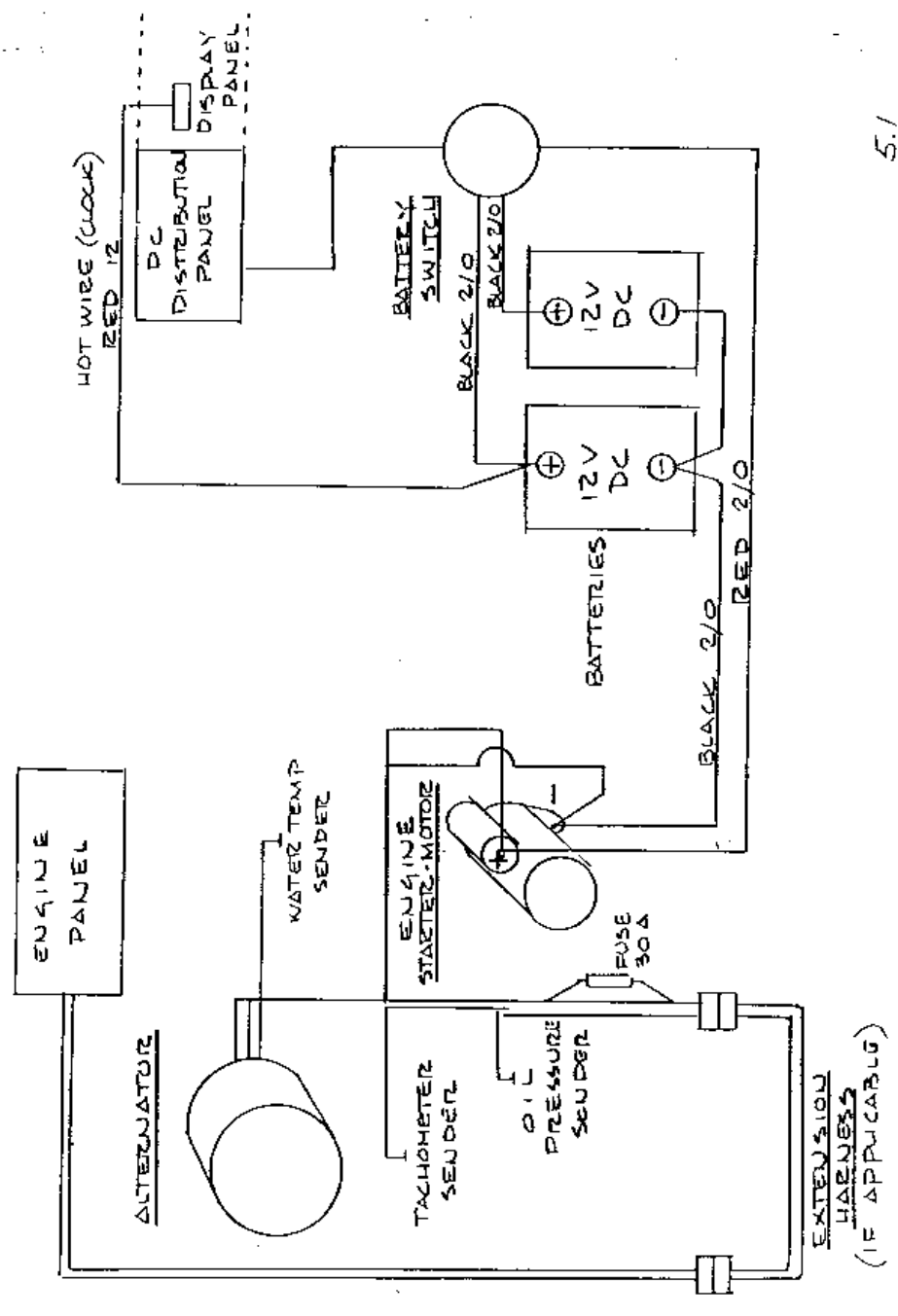

5.1

PEARSON YACHTS CORP  
ELECTRICAL PANEL

SCHEMATIC

NOTE: BREAKERS AND WIRES THAT IS OWNER/DEALER INSTALLED ARE INDICATED WITH DASHED LINES.

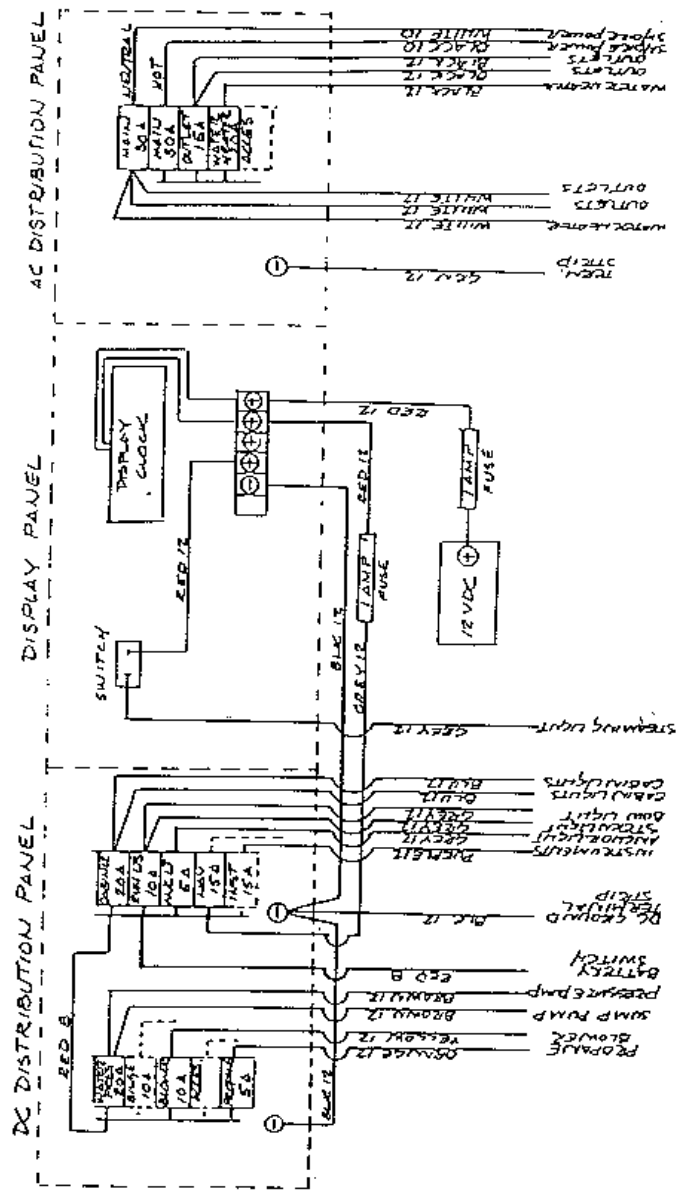

CAUTION! AS STATED, WHEN IN THE "OFF" POSITION THE BATTERY ON/OFF SWITCH COMPLETELY DISCONNECTS THE BATTERY FROM THE CIRCUIT. THIS SWITCH SHOULD NEVER BE THROWN WHEN THE ENGINE IS OPERATING AS THIS COULD CAUSE SERIOUS DAMAGE TO THE ENGINE ALTERNATOR.

The electrical system on your Pearson requires very little maintenance other than bulb replacement, an occasional check for loose terminals, and the battery care described below.

#### 5.1.1 Messenger Lines

Messenger lines have been installed in your interior and headliner units to aid you in the installation of electronics and instruments. See Fig. 5.4 and 5.5.

### BATTERY

#### 5.2

With proper care, the battery will provide long and satisfactory service, and proper care is not difficult if a few basic points are remembered.

WARNING! THE ELECTROLYTE IN A BATTERY IS A SOLUTION OF SULPHURIC ACID. IF ANY SHOULD ENTER THE EYES, RINSE IMMEDIATELY WITH LARGE AMOUNTS OF FRESH WATER, AND SEEK MEDICAL ATTENTION. ELECTROLYTE SPILLED ON SKIN SHOULD BE RINSED WELL WITH FRESH WATER. EVEN SMALL AMOUNTS OF ELECTROLYTE SPILLED ON CLOTHING WILL DESTROY THE CLOTHING.

#### 5.2.1 Electrolyte Level

The electrolyte level in a battery should never be allowed to fall low enough to expose the plates. This not only results in a loss of battery capacity while the battery is low, but will cause hardening of the active material on the battery plates, resulting in a permanent loss of battery capacity.

CAUTION! USE ONLY PURE DISTILLED WATER TO REPLENISH ELECTROLYTE LEVELS. THE WATER FROM MANY CITY WATER SUPPLY SYSTEMS IS UNSATISFACTORY FOR BATTERY USE.

#### 5.2.1.1 Battery charging

The charging of batteries is handled by the "Professional Mariner" (4 bank converter, battery charger.) Your charger is wired to the AC panel, to be used with shore power or generator. Just turn on the breaker and your batteries will be charging. To check if the charger is working, use the volt meter on the DC panel.

For detailed information, check with MFG specification and information in ship's papers.

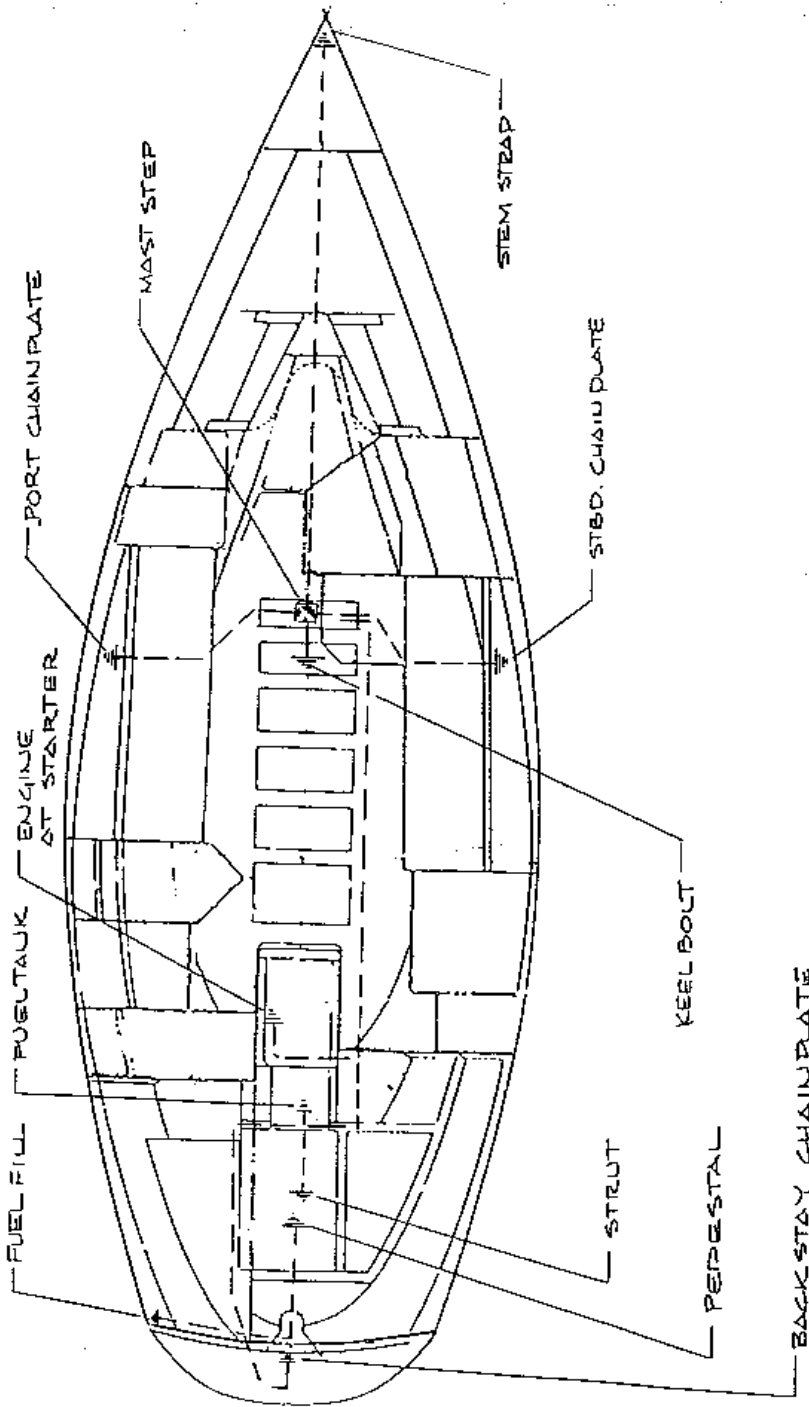

PEARSON 31  
BONDING SCHEMATIC  
 5.3



### 5.2.2 Discharged State

Leaving a battery in a discharged state for any length of time can also result in a permanent loss of capacity. Doing so in cold weather can destroy the battery since it will freeze at relatively low temperatures. At the end of each season remove your battery, charge it, and store it in a warm place (not on a cement floor). Be sure that the battery is fully charged before re-installing it in the spring.

### 5.2.3 Clean Connections

Keep battery connections clean and tight. A cup full of strong baking soda solution and a toothbrush will clean corrosion from the terminals and neutralize any spilled acid (do not allow any of the solution to enter the battery cells). A coating of petroleum jelly on the battery terminals will inhibit corrosion.

## 5.3

### LIGHTNING PROTECTION AND BONDING SYSTEMS

All Pearson yachts are fitted with lightning protection and bonding systems. These systems connect all pertinent equipment to the keel with number eight gauge stranded copper wire.

#### 5.3.1 Bonding System

The bonding system provides a path of low resistance for all attached equipment such as the fuel fill, fuel tank, generator, engine, and keel. Electrically isolated equipment (i.e., thru-hulls) are not connected to the bonding system. Eliminating this connection minimizes the effects of galvanic corrosion because the path of high resistance thus established makes it extremely difficult for electrical current to travel.

The operation of the bonding system should be checked every year at the beginning and end of each season. (See section 5.5 for proper procedure.)

Please see the bonding system diagram in this manual.

#### 5.3.2 Lightning Protection System

This system provides a "cone" of protection around the boat during an electrical storm. Remember, lightning strikes are not predictable, therefore caution is advised during a storm.

Number 8 gauge stranded copper wires connect all chainplates and the mast step to the keel.

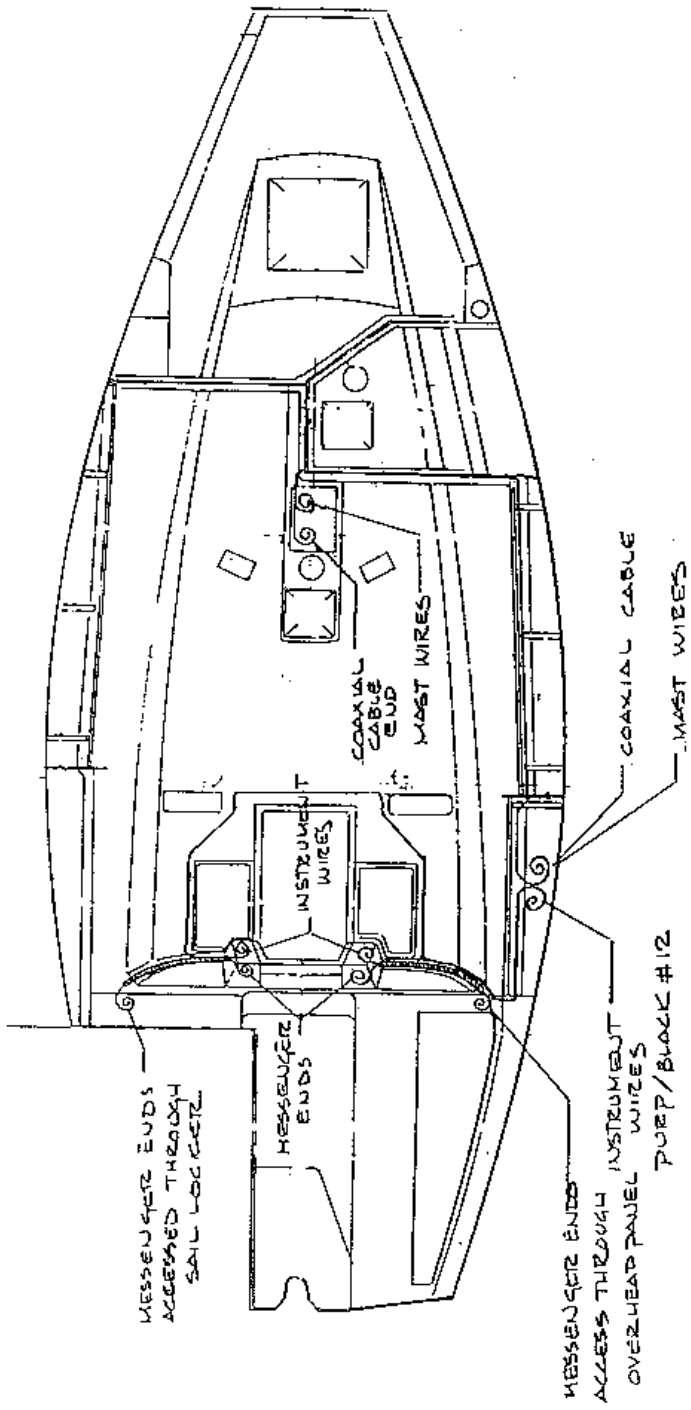

PEARSON 31  
MAST AND INSTRUMENT WIRES  
S.A

PEARSON 31  
TRANSDUCER WIRE LEADS  
 5.4.1

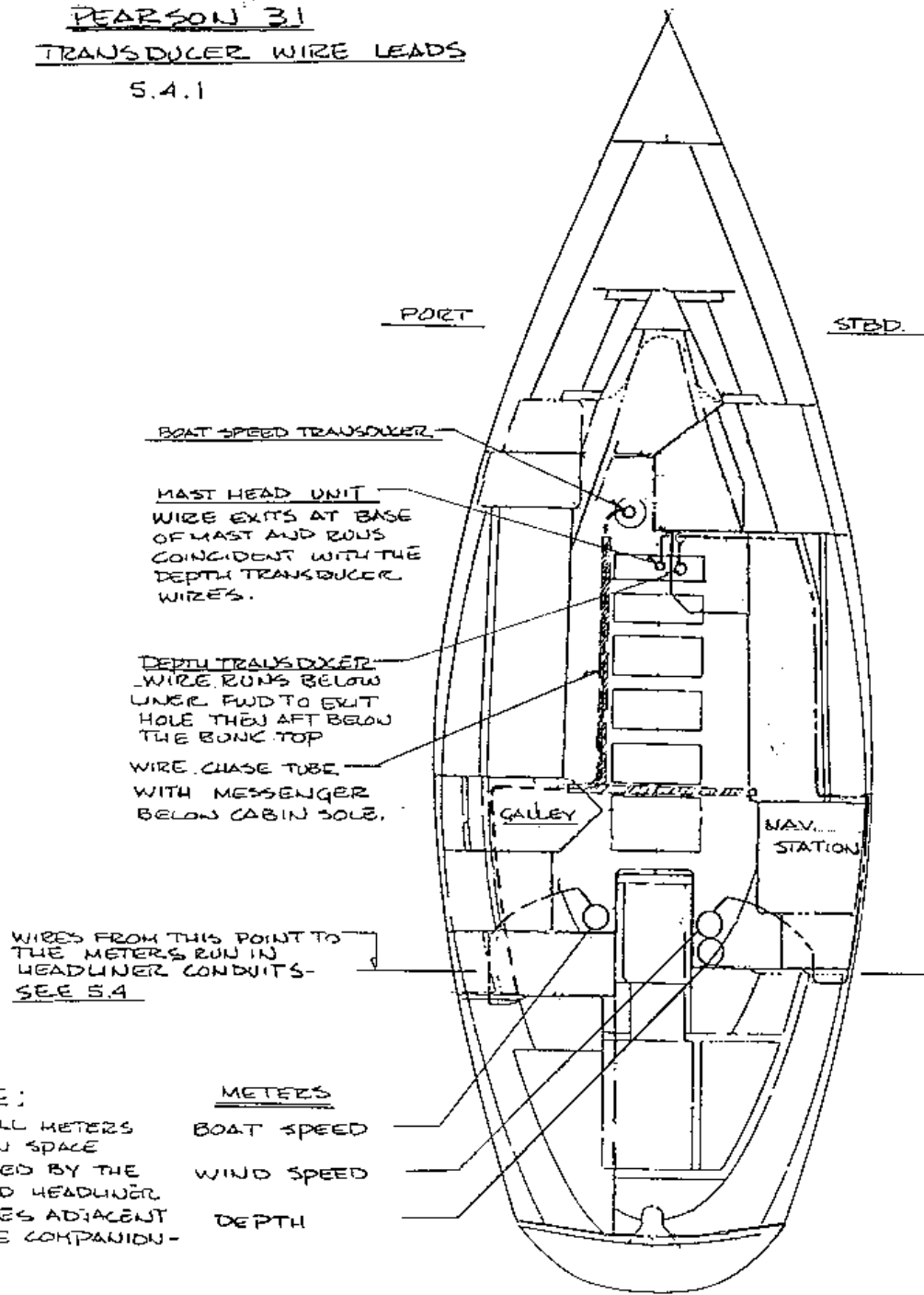

If lightning strikes, damage to electronic equipment is likely because of the high voltage, low amperage surge of electricity. Therefore, all electrical equipment including the compass must be checked for damage and or changes in calibration.

CAUTION: IN THE EVENT OF AN ELECTRICAL STORM, DO NOT ALLOW ANYONE IN THE WATER. HAVE EVERYONE ON BOARD STAY INSIDE THE BOAT. DO NOT MAKE CONTACT WITH ANY METAL OBJECT REGARDLESS IF IT IS CONNECTED TO THE LIGHTNING PROTECTION SYSTEM OR NOT, ESPECIALLY IN SUCH A MANNER AS TO BRIDGE ANY OF THESE ITEMS.

The operation of the lightning protection system should be checked every year at the beginning and end of each season (see section 5.5 for the proper procedure).

#### 5.4

##### UNDERWATER GALVANIC CORROSION

This condition occurs when dissimilar metals are in physical contact with each other in a solution (i.e. sea water). A potential difference exists between the metals which causes current to flow between them. All Pearson yachts are designed with metals that are close together on the galvanic series. Further, all electrically isolated thru-hulls are eliminated from the bonding system to eliminate a low resistance path for current. Although careful consideration is given to design, sacrificial zinc anodes should be used to protect large submerged hardware such as struts, shafts, and propellers.

##### 5.4.1 Electrolysis

Electrolysis occurs when direct current forces a metal to become "anodic". This current may come from a battery or any other external source, and because these voltages are much higher than in galvanic corrosion, the corrosion caused can be rapid.

Zinc anodes may slow down the effects of stray current corrosion, but this problem may be corrected only at its source. Most often, stray current can be traced to damaged equipment, loose and/or damaged wiring, or improperly wired equipment. In some cases, the stray current may come from a source external to the boat.

### 5.4.2 Check List

The following list may aid you in finding some of the causes of underwater corrosion. Check these wiring connections for cleanliness, integrity, and tight contact.

1. Wiring at 12 volt D.C. panel
2. Wiring on terminal strips at or near 12 volt D.C. panel
3. All bonding connections
14. Wiring on engine panel
5. Wiring on engine
6. Wiring on batteries and battery switch.
7. Wiring on mast step terminal strip.
8. Wiring on all optional equipment such as lorans, VHF radiophones, electric bilge pumps, etc.
9. Wiring on all non-factory equipment
10. Wiring on any malfunctioning equipment

## 5.5

### CHECKING BONDING AND LIGHTNING PROTECTION SYSTEMS

Check the entire bonding and lightning protection systems for proper operation. The bonding and lightning protection systems may be checked by using an ohmmeter to show that continuity exists between each piece of hardware and ground. The ohmmeter must read ~ resistance for each piece of hardware. If 11011 is not indicated for each check, the wiring and connections at both ends must be inspected, cleaned, and/or replaced.

#### NOTES:

1. All power must be disconnected before using an ohmmeter.
2. If a switch does not shut off (open) properly, it is a source of stray current.
3. Reverse wiring is a source of stray current.

#### 5.5.1 Propeller and Shaft

Propellers and shafts are large pieces of hardware with good conductivity. Therefore, they are an ideal path for stray currents to leave the boat. Thus, propeller and shaft corrosion are two of the most common results of stray current.

The propeller shaft and propeller are connected to the bonding system via a bonding strap which bridges the shaft coupling.

#### 5.5.2 Electrical Switches

Electrical switches and hardware are another major cause of stray current. The following switches and hardware should be checked for proper operating condition.

1. All 12 volt D.C. switches and circuit breakers
2. Battery switches

3. All 120 volt D.C. switches and circuit breakers
4. Battery chargers
5. Engine key switch

#### 5.5.3 External Factors

Stray current corrosion can be caused by external sources as well as internal sources. Some major causes of external current sources are:

1. Adjacent boats with current leaks
2. Polluted water
3. Dockside shore power connections
- LI. Portable battery charges
5. Water velocity and turbulence
6. Positive grounding systems on adjacent boats

NOTE: An isolater installed in the green conductor between the shore power connection and the 120 volt A.C. panel may help eliminate some of the external sources of stray current, or an isolation transformer may be installed in all three wires between the shore power connections and the 120 volt A.C. panel to help eliminate stray currents for external sources.

YACHT SYSTEMS - STEERING  
SECTION 6

6.1 GENERAL DESCRIPTION

6.1.1 Wheel Steering System

Your Pearson employs a pedestal steerer utilizing a cable steering system. If your yacht is equipped with the brake mechanism located on the starboard side of the pedestal, it permits the wheel to be locked in position if desired.

The maintenance that is required for the steering system consists largely of oiling and greasing the mechanism and adjusting the cable. All of this is well-covered in the manufacturer's literature that is supplied at commissioning. It is recommended that the procedures described in this literature be followed to ensure many years of trouble free service.

6.1.2 Emergency Tiller

The steering system includes an emergency tiller that can be fitted over the rudder stock head in the event that a failure should occur in the pedestal system. Access the rudder stock head is gained by removing the cover over the rudder stock located at the aft end of the cockpit allowing the emergency tiller to be installed.

A dry run of your emergency tiller system in stable conditions will lessen confusion in times of crisis. Once aboard, make sure the emergency tiller is stowed in the sail locker in an easily accessible place.

NOTE:  
SYSTEM  
CLEAR.

THE EMERGENCY TILLER WILL MOVE THE WHOLE STEERING  
SO EACH PART INCLUDING THE CABLE AND RUDDER MUST BE

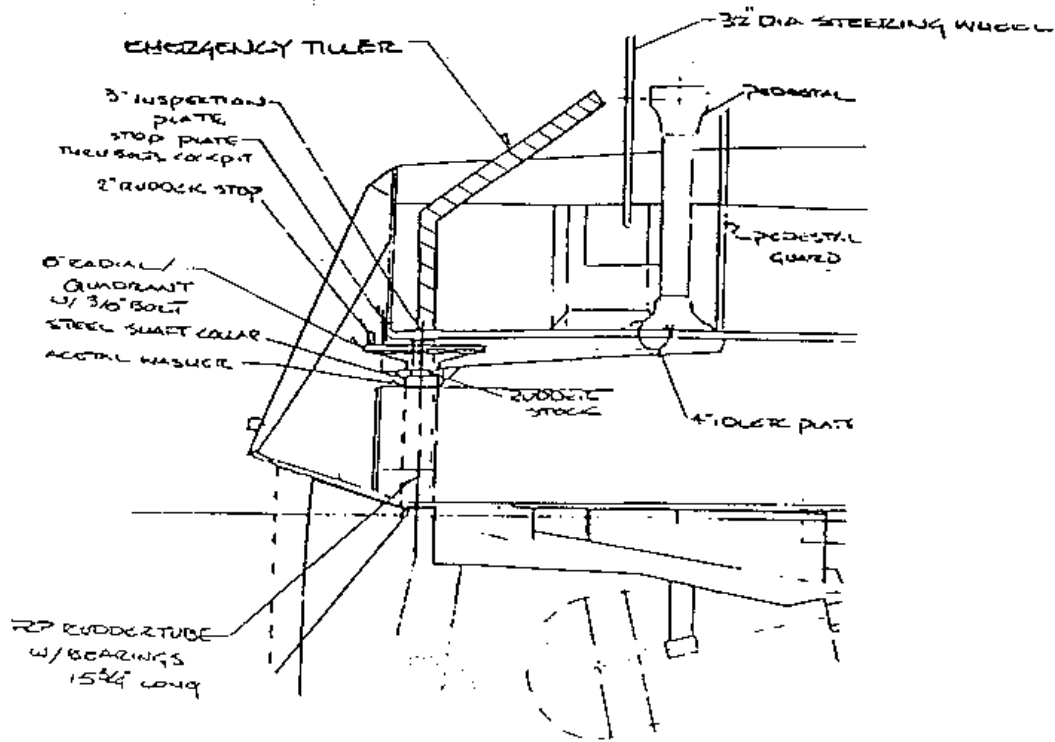

TO INSTALL THE EMERGENCY TILLER, REMOVE THE CAP ON THE DECK PLATE WHICH IS BELOW THE HELMSMAN SEAT. THEN INSERT THE SLOTTED END OF THE EMERGENCY TILLER INTO THE EXPOSED END OF THE RUDDER STOCK.

NOTE: SOME EMERGENCY TILLERS INTERFERE WITH THE STEERING WHEEL SO THE STEERING WHEEL MUST BE REMOVED PRIOR TO THE EMERGENCY TILLER INSTALLATION.

#### EMERGENCY TILLER INSTALLATION

6.1



## YACHT SYSTEMS - HULL

## SECTION 7

## 7.1 THRU-HULL FITTINGS

A number of the standard and optional systems used on the Pearson must penetrate the hull for intake of water. In addition, scuppers, drains, and certain waste discharge systems are also brought out below the water line. Knowledge of the precise location of each thru-hull is important, and should be one of the first things a new owner learns about his boat. Thru-hull locations are illustrated on the next page.

## 7.2 FRESH WATER SYSTEM

The diagram in Fig. 7.2 shows the fresh water system installed on your Pearson.

## 7.2.1 Hot/Cold Pressure Water System

Normal operation of the pressure system simply involves energizing the WATER PRESSURE circuit breaker on the DC panel. The pressure pump will then turn itself on and off whenever a faucet is opened or closed. If the system is being started up after a long shut down, or after having run the system dry, it may be necessary to perform the following steps:

Open all faucets, hot and cold.

Energize the "WATER PRESSURE" circuit breaker.

Close each faucet when it starts to deliver a steady stream of water (cold water faucets first).

The pump should stop operating shortly after the faucet is closed, and the system is now ready for automatic operation.

## 7.2.2 Water System Maintenance

The manufacturer's literature supplied at commissioning provides the necessary information for maintenance and winterization of the water system.

- ① ENGINE SALT WATER INTAKE
  - ② HEAD INTAKE
  - ③ HEAD OVERBOARD DISCHARGE
  - ④ BILGE DISCHARGE
  - ⑤ PUMP DISCHARGE
  - ⑥ GALLEY SINK DRAIN
  - ⑦ VANITY SINK DRAIN
  - ⑧ PROPANE BIN VENT
  - ⑨ PROPANE BIN DRAIN
  - ⑩ PELIC DRAINS
  - ⑪ COCKPIT DRAINS
  - ⑫ EXHAUST FLANGE
  - ⑬ FUEL TANK VENT
  - ⑭ ANCHOR LOCKER DRAIN
  - ⑮ WATER TANK VENTS
- \* WATER TANK VENTS EFFECTIVE WITH HULL NO 173

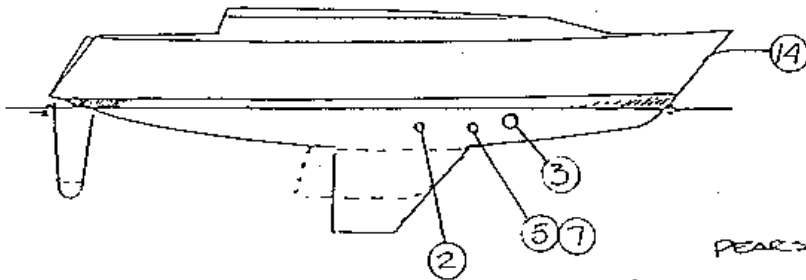
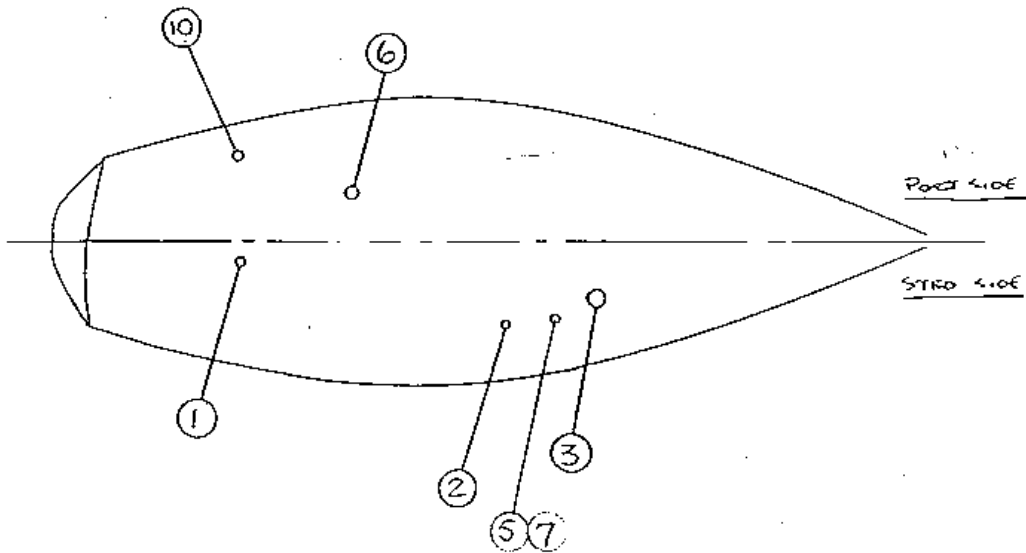
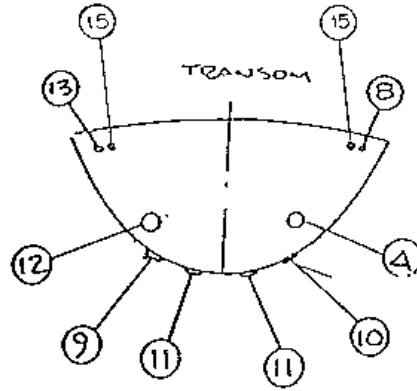

PEARSON 31  
THRU-HULL LOCATIONS  
7.1

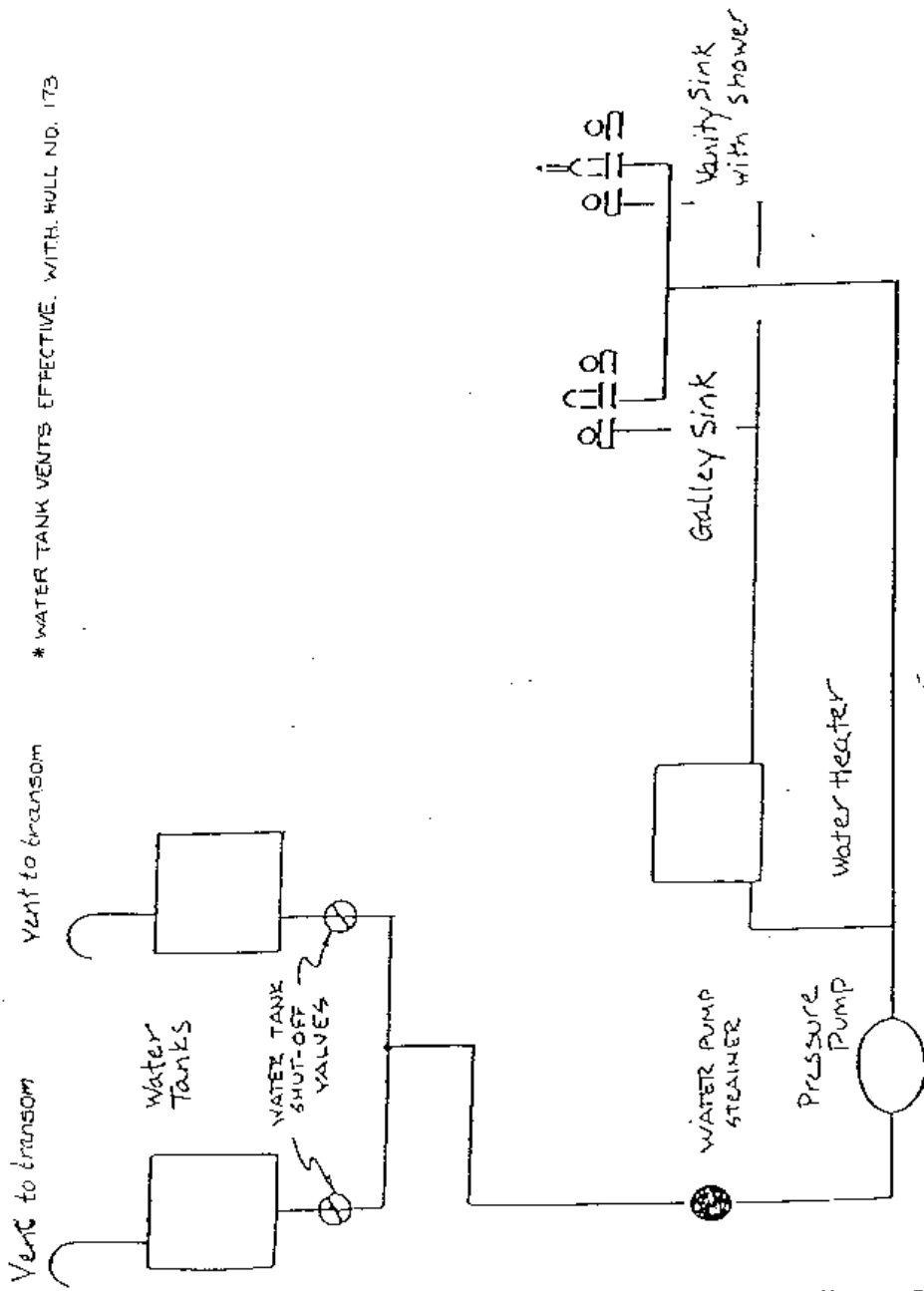

\* WATER TANK VENTS EFFECTIVE. WITH HULL NO. 173

FRESH WATER SYSTEM

7.2

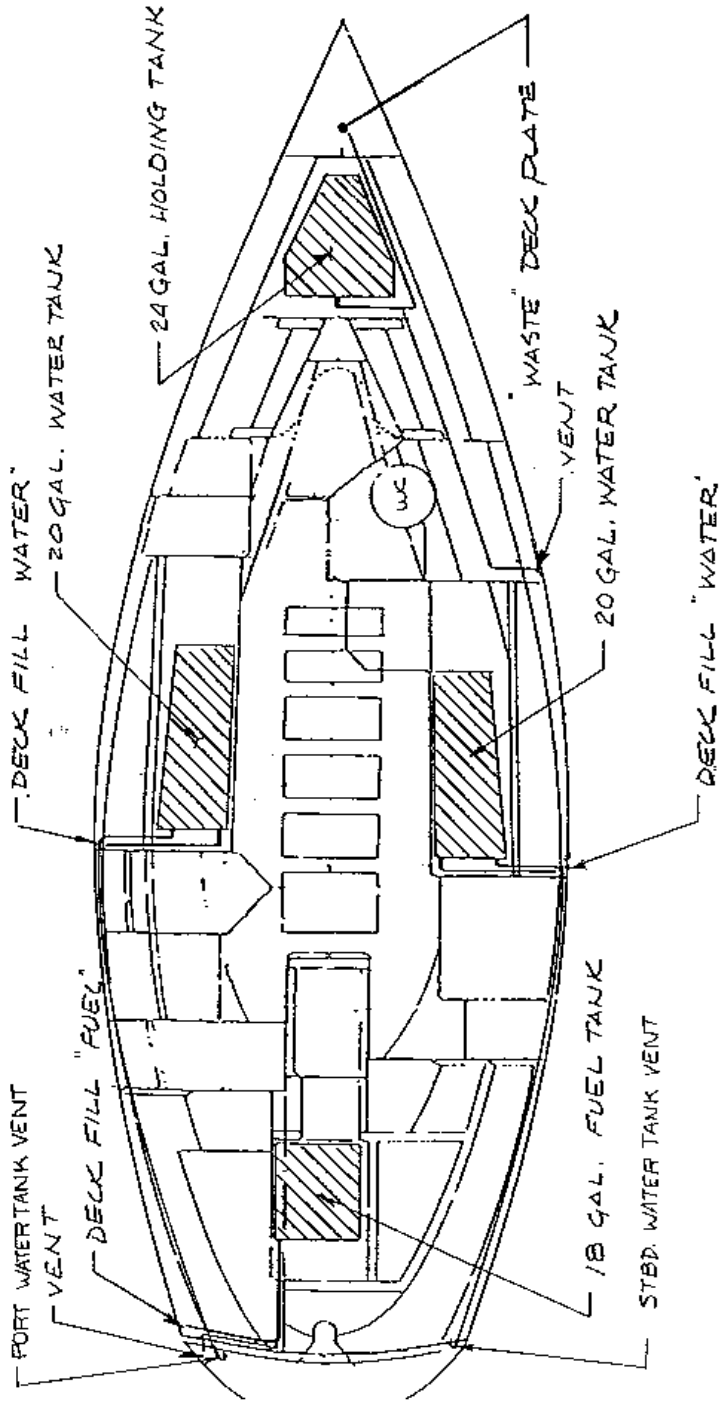

WATER TANK VENTS EFFECTIVE WITH HULL NO. 173

PEARSON 31  
TANK LOCATIONS  
7.2.1

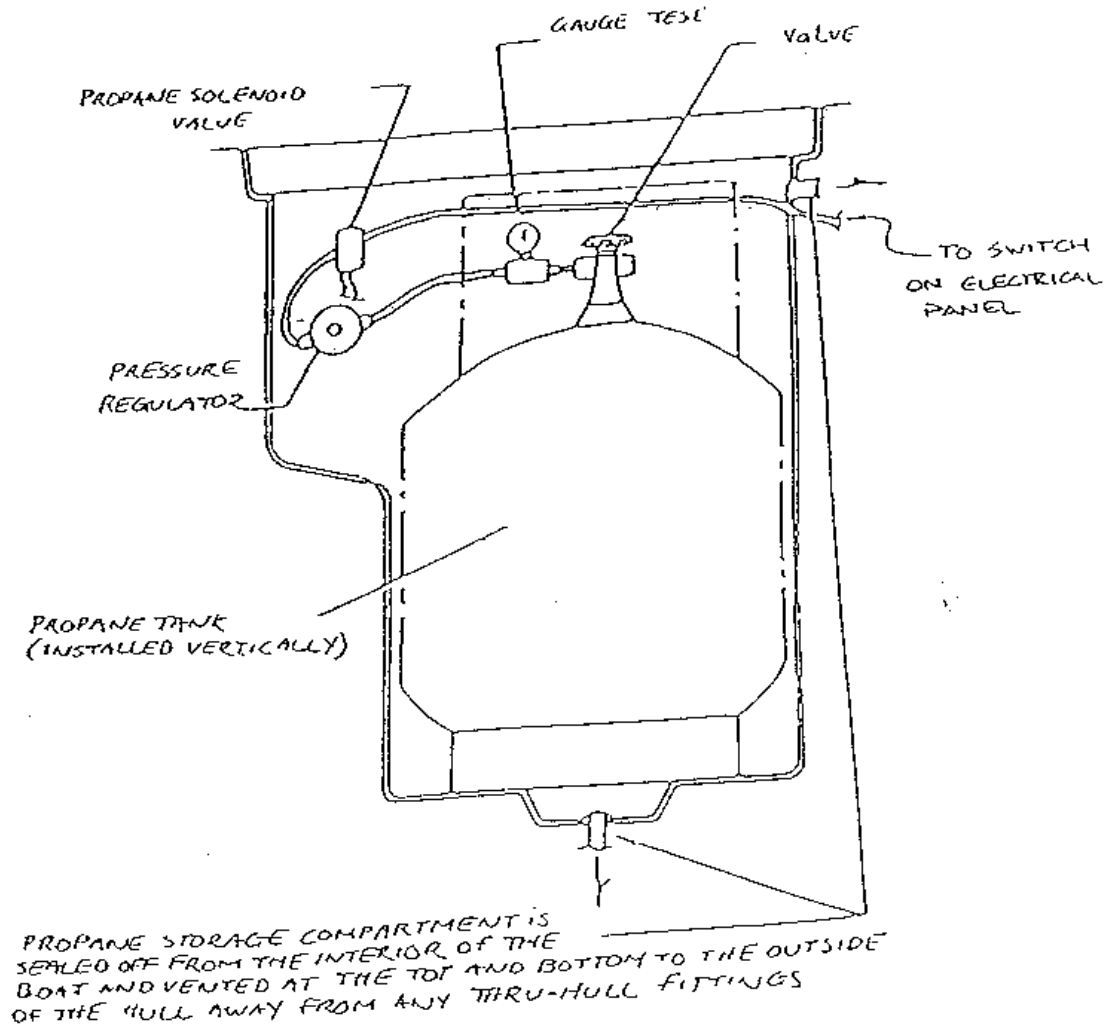

7.3

PROPA NE SYSTEM  
INSTALLATION SCHEMATIC

- 7.3 PROPANE SYSTEM. The use of ranges and ovens fueled by propane requires installation in accordance with rigid specifications in order to safeguard against gas leakage into bilge areas. Two items of extreme importance in these specifications are: (1) the installation of a propane storage tank in a compartment that is sealed off from the interior of the boat and vented overboard, and (2) the inclusion of a shutoff system that ensures the shutting off of the fuel supply outside the interior of the boat when the stove is not actually in use.

Figure 7.3 illustrates the method employed on the Pearson 36 to satisfy these requirements. A propane tank is mounted in a molded-in storage locker in the cockpit. The tank is connected to the system as shown in the illustration with the lowest point of the locker vented overboard. The circuit breaker on the electrical panel labeled PROPANE controls a solenoid valve in the locker. A red indicator light on the electrical panel indicates when the circuit is energized. A manual shutoff, a gauge, and a pressure regulator complete the installation.

A small amount of power (less than 15 watts) is required to operate the valves and indicator light, and current is drawn only when the system is energized. The system can be regarded as fail safe since loss of power will result in automatic valve shutoff.

7.3.1 Operation. Perform the following steps:

- a. Ensure that the propane tank manual shutoff is open, and that the gauge indicates sufficient pressure in the tank.

NOTE

THE MANUAL CONTROL VALVE IN THE STORAGE LOCKER MAY BE LEFT OPEN WHILE THE YACHT IS OCCUPIED, BUT FOR ADDED SAFETY, THE MANUAL SHUT-OFF WOULD BE CLOSED WHEN THE YACHT IS LEFT UNATTENDED FOR ANY LENGTH OF TIME.

- b. Energize the PROPANE switch on the electrical panel, and observe that the red indicator light is illuminated.
- c. Open the range valve serving the desired burner and light the burner.
- d. To shut off after cooking is completed, deenergize the PROPANE switch on the electrical panel, and after the burner flame is extinguished, turn off the valve on top of tank in the cockpit locker.

- 7.3.2 Although propane gas is odorless, a special ingredient is added to impart a distinctive odor to the gas as an aid in the detection of leaks. Should this odor be detected in the vessel when the equipment is thought to be secured, or if a leak is suspected for any other reason, it is important that steps be taken to find the cause. If the leak cannot be found, or if doubt exists about the ability to effect repairs, the services of qualified technical personnel should be employed.

A simple test procedure that can be used to check system for leaks is as follows:

- a. Ensure that the switch on the electrical panel is in the OFF position.
- b. Open the cylinder shut-off valve and observe the pressure reading on the gauge.
- c. Close the cylinder shut-off valve. On a system free of leaks, the reading on the gauge will remain constant for several minutes after the valve is closed.
- d. If a leak is suspected beyond the solenoid valves, repeat steps 2 and 3 with the electrical panel energized and the burner valves closed.

WARNING!

NEVER USE AN OPEN FLAME SUCH AS A  
MATCH OR CANDLE TO SEARCH FOR LEAKS.

the

A solution of soapy water applied to fittings, and a search for bubbles with the system under pressure, is a safe, useful procedure for localizing a leak.

#### 7.4 Head and Waste Systems

The waste system is comprised basically of a marine toilet, Y-valve, holding tank, and a series of valves and hose runs for intake and discharge of sea water and waste.

The marine head intakes water through a 3/4" seacock located in the forward end of the starboard settee. To flush, open the seacock and the valve handle on the toilet pump cylinder. Then pump the handle until the bowl is flushed clean. Reset the valve handle to the dry flush position.

The holding tank is located below the V-berth top. It has a 25-gallon capacity and may be pumped dry via a shore pumpout system connected to the deck plate marked "waste." Limit pumping strokes at the head when discharging into the holding tank to maximize its use.

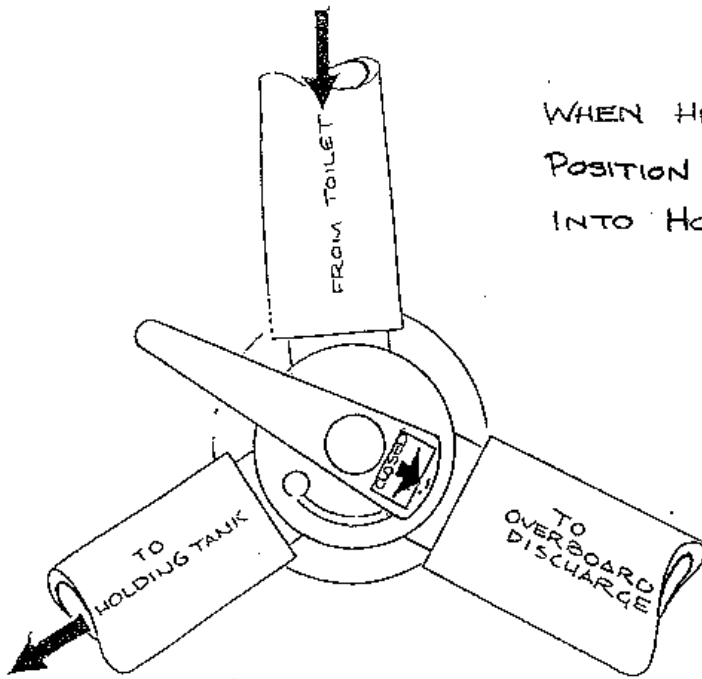

WHEN HANDLE IS IN THIS POSITION TOILET DISCHARGES INTO HOLDING TANK

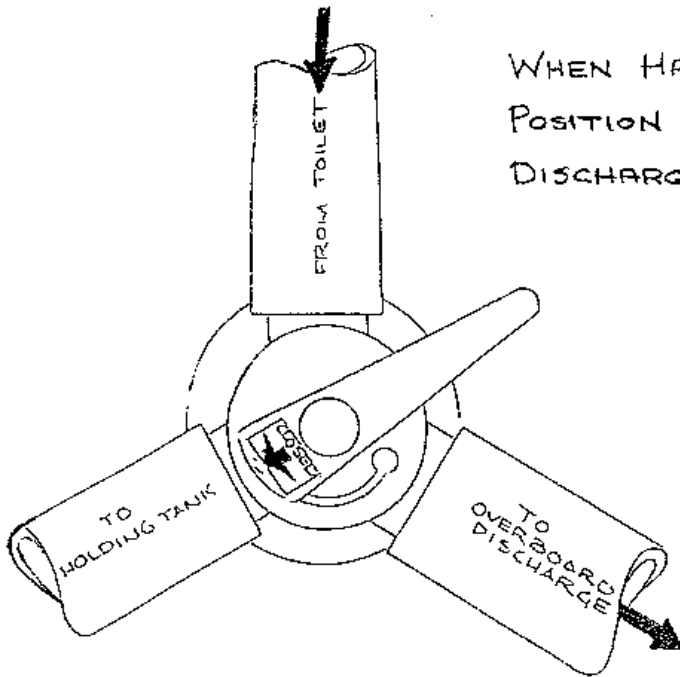

WHEN HANDLE IS IN THIS POSITION TOILET DISCHARGES OVERBOARD



## MAINTENANCE SUMMARY

## SECTION 8

## 8.1 INTRODUCTION

This section of the manual consists of a summary of the maintenance required for the hull proper and for the various systems installed in your boat. The section is divided into three categories:

## ROUTINE MAINTENANCE

Those tasks that should be performed on a regular basis. These range from daily routines such as engine fluid level checks, to tasks such as bottom painting that normally fall into annual cycles.

## LAYING UP

Tasks to be performed if the yacht is to be stored for a period of time, especially during cold weather.

## FITTING OUT

Tasks required to place the yacht back in commission after a lay-up period.

It should be evident that it is not possible to draw up precise maintenance schedules that will completely satisfy the requirements of each individual yacht. For example, a vessel receiving moderate use in the summer can have the bulk of the routine maintenance at the beginning or end of the winter lay-up period. Yachts used throughout the year will have to schedule time to perform these tasks.

## 8.2

## ROUTINE MAINTENANCE

Many of the routine maintenance tasks, such as care of teak, can be performed when the need becomes evident; others such as checking engine oil level, must be performed on a regular schedule if expensive repair bills are to be avoided. Recommended schedules have for the most part been taken from the literature supplied by the manufacturers of the equipment installed in the yacht. Additional information that may be desired should be taken from these sources.

## 8.2.1 Topsides, Decks, And Below Decks

## 8.2.1.1 gelcoat

A fresh water hose-down of deck and topsides at every opportunity, plus an occasional washing with soap and water, will help preserve the gelcoat surfaces. Use a sponge or a soft brush on the smooth surfaces, and a stiff brush on the non-skid areas. Rinse thoroughly with fresh water to avoid streaking.

CAUTION! DO NOT USE ABRASIVE CLEANERS FOR CLEANING.  
IT WILL RAPIDLY DULL THE GELCOAT SURFACE.

NOTE: ON SOME MODELS, THE HEAD SINK BASIN HAS A GELCOAT SURFACE AND WILL BE DAMAGED BY THE USE OF ABRASIVE CLEANERS.

At least once a year, the smooth gelcoat surfaces should be cleaned thoroughly, washed and polished. Acetone can be used for cleaning stubborn areas. Abrasive cleaners should be used sparingly, if at all. Use a wax especially formulated for fiberglass surfaces.

CAUTION!! NEVER USE ACETONE ON ANY PLASTIC PARTS, SUCH AS PORTS OR HATCHES, ETC. AVOID USING TOO MUCH ACETONE OR FROM PUDDLING THE ACETONE ON GELCOAT SURFACES. ANY GELCOATED AREAS THAT HAVE COME IN CONTACT WITH ACETONE SHOULD BE WIPED OFF AND RINSED IMMEDIATELY WITH FRESH WATER.

#### 8.2.1.2 wood surfaces

Depending on the personal preferences of the owner, exterior teak may be oiled, varnished, or left alone. If left untreated, exterior teak takes on a gray appearance that is pleasing to some people, but requires almost constant scrubbing to keep presentable. Varnished teak retains a fresh light color, but requires a lot of attention since varnish does not adhere well to teak. Oiled teak is the easiest to maintain although it has a tendency to darken with age. A number of excellent products for maintaining oiled teak are available, and the instructions regarding their use should be followed carefully.

CAUTION! THE USE OF COMMERCIAL TEAK CLEANERS SHOULD BE AVOIDED. IF ANY ARE USED, GREAT CARE MUST BE EXERCISED TO KEEP THE CLEANER FROM COMING IN CONTACT WITH ADJACENT SURFACES SINCE IT CAN DAMAGE VARNISHED, PAINTED, OR GELCOAT SURFACES.

When a lighter finish is desired with oiled teak, the dark outside layer of wood can be removed by rubbing with bronze wool or fine sandpaper. After rubbing, the teak should be well-oiled.

CAUTION! NEVER USE STEEL WOOL FOR ANY KIND OF CLEANING ON A YACHT. SMALL PARTICLES WILL REMAIN, CAUSING RUST SPOTS THAT ARE DIFFICULT TO REMOVE.

The interior wood finishes on your Pearson should last for several seasons before requiring renewal. It should, however, be kept in mind that it is far easier to refinish a surface in fair-to-good condition than to refinish a surface that has been allowed to deteriorate.

### 8.2.1.3 window maintenance

A dab of petroleum jelly on the threads of the toggles (only) will prevent corrosion. Twice annually, scrub the gaskets with clean water and an old tooth brush. When dry, dust with talc powder to resist sticking to the window. Clean the window with clean cold water or with cleaner and polish. NEVER WIPE THE WINDOW WHEN DRY, DIRT OR SALT WILL SCRATCH THE SURFACE.

CAUTION!! NEVER USE SPRAY LUBRICANT, WD-40 OR THE LIKE, ON ANY INJECTION MOLDED PARTS IN YOUR YACHT, THE CHLORINATED HYDROCARBONS CONTAINED THEREIN TO DISSOLVE RUST MAY INDUCE STRESS WITH RESULTANT BREAKAGE.

### 8.2.2 Below the Waterline

With the exception of small craft that are removed from the water after each use, all vessels require some form of bottom protection to avoid the accumulation of bottom growth. This usually needs to be done on a yearly basis. Although fresh water areas do not generate as much fouling as occurs in salt water, it nevertheless will cause growth of moss, grass, and other flora that will significantly affect the performance of the yacht.

#### 8.2.2.1 bottom cleaning

Cleaning the accumulated growth from a boat bottom is far easier when the growth is wet than after it has been allowed to dry out. While still wet, a power spray and stiff brush will remove most bottom growth. Barnacles that resist this action can be removed with a scraper.

NOTE: WHILE CLEANING THE BOTTOM, REACH INTO THRU-HULLS, CENTERBOARD TRUNK, BETWEEN THE SKEG AND THE RUDDER TO REMOVE ANY BARNACLES.

#### 8.2.2.2 bottom preparation

Most bottom paints require removal of all loose material from the bottom, and a thorough but light sanding of any portions of the old paint that remains in good condition. A proper sanding procedure will normally take off approximately the same amount of old paint as is intended to be reapplied. This avoids excessive paint accumulation that will eventually cause peeling and roughness on the bottom.

#### 8.2.2.3 bottom painting

The actual formula of the bottom paint that should be applied is, to a great extent, determined by the general area in which the yacht is expected to operate (fresh or salt water, temperate or tropical areas etc.) Local advice from reputable yards is helpful. Application of bottom paint should always conform to the manufacturer's instructions if maximum effect is to be achieved. Some

bottom paints recommend thinning, others do not. Some specify that the boat be returned to the water before the paint has completely dried out (usually 3 or ~ days), and others make no qualifications in this area but may have other requirements.

CAUTION! SOME BOTTOM PAINT FORMULAS ARE NOT COMPATIBLE WITH OTHERS AND CANNOT BE APPLIED DIRECTLY OVER ONE ANOTHER WITHOUT PROPER PREPARATION. THE OWNER SHOULD KEEP A RECORD OF THE TYPE BOTTOM PAINT THAT IS IN USE TO AVOID ANY PROBLEMS IN THIS AREA.

### 8.2.3 Winches

Perform maintenance in accordance with the manufacturer's instructions provided at commissioning. This involves periodic disassembly, cleaning, and lubricating.

### 8.2.4 Spars and Rigging

Aluminum spars and stainless steel rigging require little routine maintenance other than cleaning, and regular on-going checks for signs of wear. Some cleaning and inspection procedures are included in the following paragraphs:

#### 8.2.4.1 cleaning wire rope and rigging

Using a stiff brush or nylon pads, clean with fresh water and detergent. Rinse thoroughly.

#### 8.2.4.2 cleaning synthetic rope

When practicable, soak overnight in warm soap and water, rinse thoroughly, dry before storing.

#### 8.2.4.3 rigging inspection

At least once a season, make a complete inspection of all the yacht's rigging and fittings. Check fittings for cracks and other signs of wear. Check that cotter pins are secure and properly taped. Check running rigging for "lburrs", kinks, etc.

### 8.2.5 Power System

Details for most of the engine maintenance procedures are contained in the engine manual with the following being a brief summary of items that should receive frequent attention. For long engine life and efficient operation, the complete maintenance schedule as set up in the engine manual should be followed.

## DAILY

Check engine coolant level.

Check engine lube oil level.

Check transmission fluid level.

EVERY 100 HOURS, OR TWICE A SEASON (WHICHEVER COMES FIRST)

Clean air intake filter

Check packing gland on stuffing box for excessive leakage.

EVERY 100 HOURS, OR ONCE A SEASON (WHICHEVER COMES FIRST)

Change engine lube oil. (See engine owner's manual.)

Renew engine lube oil filter element.

Clean primary and secondary fuel filters, renew primary filter element, bleed fuel lines.

## 8.2.6 Electrical System

## BI WEEKLY

Check the electrolyte level in the battery and fill with pure distilled water if required.

## TWICE EACH SEASON

Remove, clean, and retighten battery terminals.

Clean battery surfaces with a solution of baking soda.

Apply coating of petroleum jelly to battery terminals.

## 8.2.7 Steering System

Maintenance of the steering system should be in accordance with the manufacturer's instructions that were provided at commissioning. Basically, the requirements are as follows:

## MONTHLY

Oil sheave bearings.

## QUARTERLY

Install the emergency tiller and check its operation.

## ANNUALLY

Check and oil the steering cable.

Check and oil the roller chain.

Check and grease the pedestal shaft bearing.

### 8.3 Laying up

The most common reason for laying-up a yacht is for winter storage in cold climates. The following paragraphs are oriented to that purpose, but the procedure will also be of value, with winterizing procedures omitted, if it becomes necessary to lay-up the yacht for an extended period in a warm climate.

Improperly winterized equipment can result in expensive repair bills and needless delays at the beginning of the new season. In addition, accumulations of gear left in a poorly ventilated yacht can either corrode or generate a bumper crop of mildew. The owner must ensure that proper lay-up procedures are performed if the yacht is to be ready for recommissioning at the end of the lay-up period.

#### 8.3.1 BEFORE HAULING

Consult engine manual instructions for winterizing the engine. Perform the appropriate steps while the boat is still in the water.

If it is intended to disconnect the shaft coupling during haul-out, do so at this time (paragraph 4.6.2.1).

Consult the manufacturer's instructions for winterizing any optional or owner-installed equipment. Perform appropriate procedures before batteries are disconnected.

#### 8.3.2 AFTER HAULING

Wash bottom.

Wash topsides, deck, and all other exterior fiberglass surfaces. Wax all except the non-skid surfaces.

Remove all sails; follow sailmaker's instructions in regard to cleaning, and store in a dry place.

Remove all sheets and lines, clean, store in a dry place.

If the mast has been removed from the yacht, remove all stays and shrouds from the mast. Wash the entire stay or shroud assembly, using fresh water and a stiff brush, dry thoroughly, and coil into large non-kinking coils. Store the coils in a dry place. Wash and wax all spars, coil halyards into non-kinking coils, and secure them to the mast. Store the mast outside with adequate support along its length.

If mast is to remain stepped, remove boom, clean and store as described before; clean shroud/stay end fittings, toggles, etc. using fresh water and a stiff brush; apply a light coating of silicone grease, paying particular attention to the end fittings where they connect to the stays and shrouds.

Clean and lubricate all deck hardware that contain moveable parts. Follow manufacturer's instructions on winches.

Remove all gear such as books, documents, bedding, PFDs, anything moveable that is subject to rust, corrosion or mildew.

Remove all food supplies from lockers and ice chest. Wash out ice chest interior with a weak solution of Glorox. Prop ice chest lid open.

Winterize the hot and cold water system in accordance with manufacturer's instructions prior to disconnecting the batteries.

Stored batteries should be fully charged, and both positive and negative terminals should be disconnected. The batteries should be stored in a cool, dry place.

Close all manual shut-offs for the propane system.

Winterize the head system in accordance with manufacturer's instructions.

Remove all electronic gear that may require servicing during the winter.

Remove fire extinguishers for weighing, checking, and any necessary recharging. If an automatic fire extinguishing system is installed, return the cylinders to the yacht and re-install as soon as possible.

If security is likely to be a problem, remove easily stolen items such as compasses and radio transmitters; store in a safe place.

If cushions are left aboard, place on edge to encourage ventilation.

Leave all interior lockers and floorboards open to encourage ventilation.

Ensure that cockpit and deck scuppers are open and free.

If the boat is to be covered, ensure that the cover is installed in such a way as to provide adequate ventilation, and that the cover is not permitted to chafe against portions of the hull.

If the boat is not to be covered, ensure that mechanisms such as winches and steering pedestals are provided with adequate covers.

If the mast is to remain stepped, snub all shrouds and halyards to minimize noise and wear.

#### 8.4 FITTING OUT

Fitting out is the performance of the tasks required to place a yacht into service after a lay-up period. Since it is, in effect, the recommissioning of the vessel, the procedure provided in Section 3 (Commissioning) of this manual should once again be followed along with these additions:

Follow the procedure outlined in the engine manual for placing the engine back in service after lay-up.

Follow manufacturers' instructions for placing the following equipment back in service:

- pressure water system
- hot water system
- head system
- steering system
- winches
- other optional system

If the mast was removed during lay-up, the tuning procedures outlined in paragraphs 3.3 and 3.4 should be performed in addition to the steps in the commissioning procedure.

Make a complete inspection of all standing and running rigging. Look for signs of stress or cracking at fittings; evidence of fraying, chafing, kinking; cotter pins are secure and taped. Pay particular attention to the wire-to-rope splice on halyards.



## DRAWINGS AND KEEL BOLT TORQUE VALUES

## Section 9

The additional drawings are larger than a normal page. I have copied them so that you can fit the first two pages together to make drawing 1 and the second 2 pages together to make drawing 2

I also have a large blueprint that gives the sail plan. This is the drawing that was issued to the sail makers. I can have a copy produced mail it to you for the cost of the reproduction.

Contact me at:

Bill Crane

Billosail@aol.com

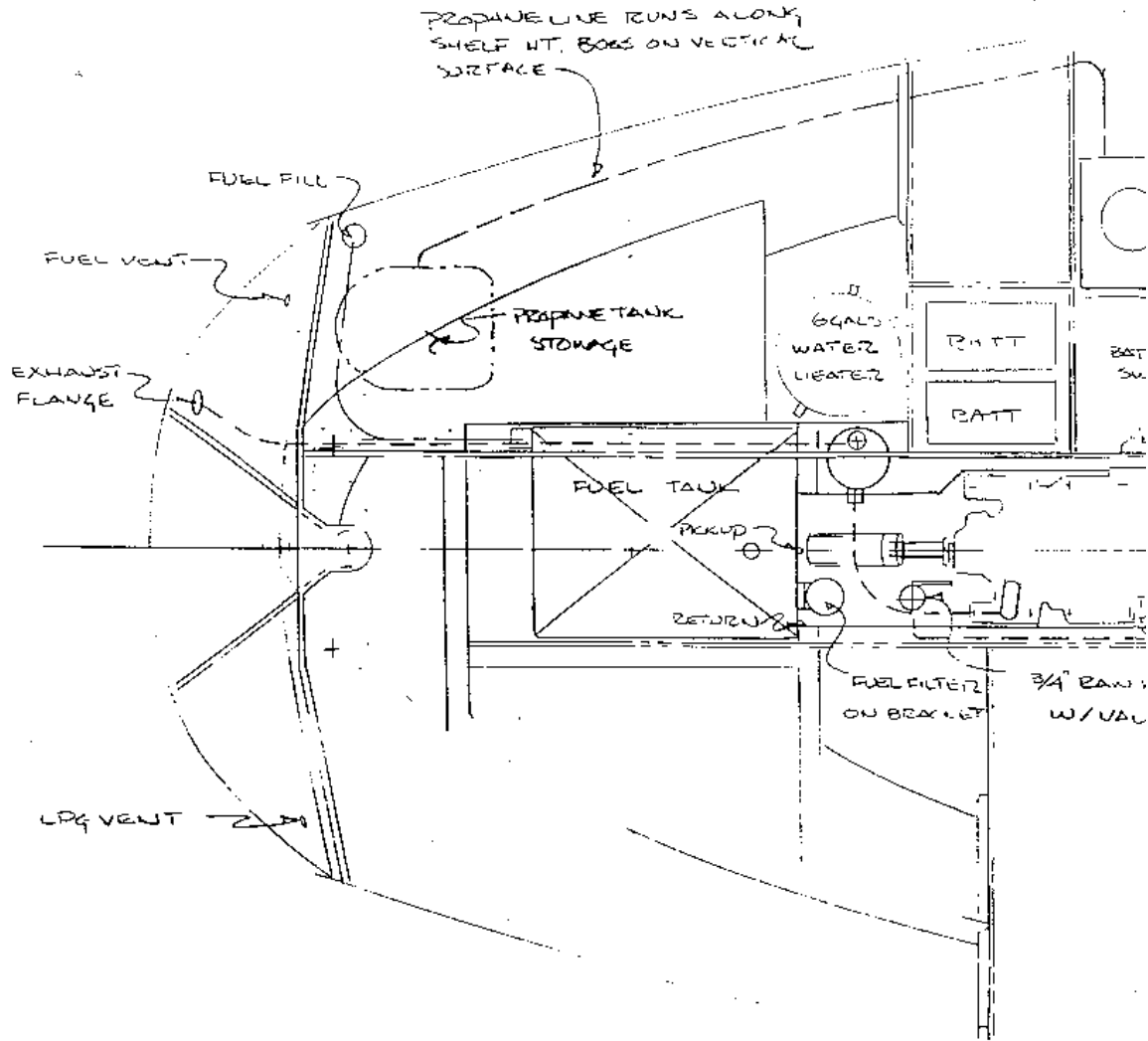

GENERAL NOTES

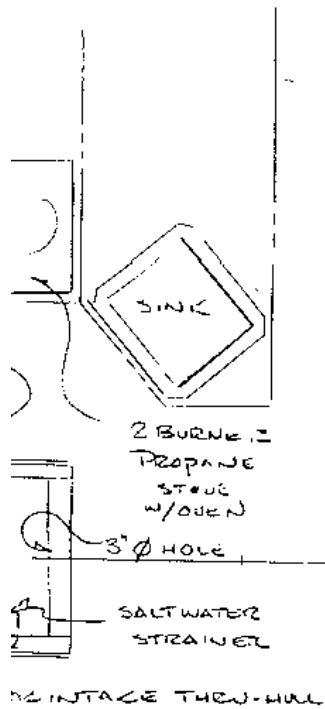

1. THROTTLE AND CLUTCH CABLES RUN INTO THE PORT SIDE OF THE LINER FROM THE LAZZARETTE AREA. THEY EXIT THE LINER AND RUN BELOW THE FUELTANK. TO THEIR RESPECTIVE ATTACHMENT POINTS ON THE ENGINE.
2. THE ENGINE WIRING HARNESS RUNS FROM THE ENGINE PANEL ON THE PORT SIDE, ALONG THE UNDERSIDE OF THE COAMING TO THE FORWARD SAIL LOCKER BULKHEAD. IT THEN RUNS DOWN THE BULKHEAD TO THE ENGINE.
3. THE BILGE PUMP HOSE RUNS FROM THE BILGE PUMP, MOUNTED ON THE PORT BACKREST FACE 9" AFT OF THE SEAT LOCKER OPENING UNDER THE COAMING (THE WRAPPED TO THE UNDERSIDE OF THE WINCH ISLAND), TO THE FORWARD SAIL LOCKER BULKHEAD FROM WHICH POINT IT PASSES DOWN BELOW THE ENGINE INTO THE BILGE AREA FORWARD OF THE ENGINE.
4. THE 3" EXHAUST BLOWER MOUNTS TO THE BACKSIDE OF THE COCKPIT SIDE WALL (PORTSIDE). REFERENCE THE DECK PLAN. THE HOSE RUNS OUTBOARD BELOW THE WINCH ISLAND COAMING, FORWARD THEN INBOARD TO THE ENGINE ROOM. MOUNT OPEN END AT THE HIGHEST POINT CLOSEST TO THE EXHAUST ELBOW.
5. SEE PRESSURE WATER DRAWING TO DETAIL PUMP, TANK AND HOSE ROUTING.
- 6.

PEARSON 31 II

MACHINERY ARRANGEMENT

PLAN VIEW

SHT 1 OF 2

SCALE 3/4" = 1'-0"

D-3435

3-13-86

CLL WSHZ

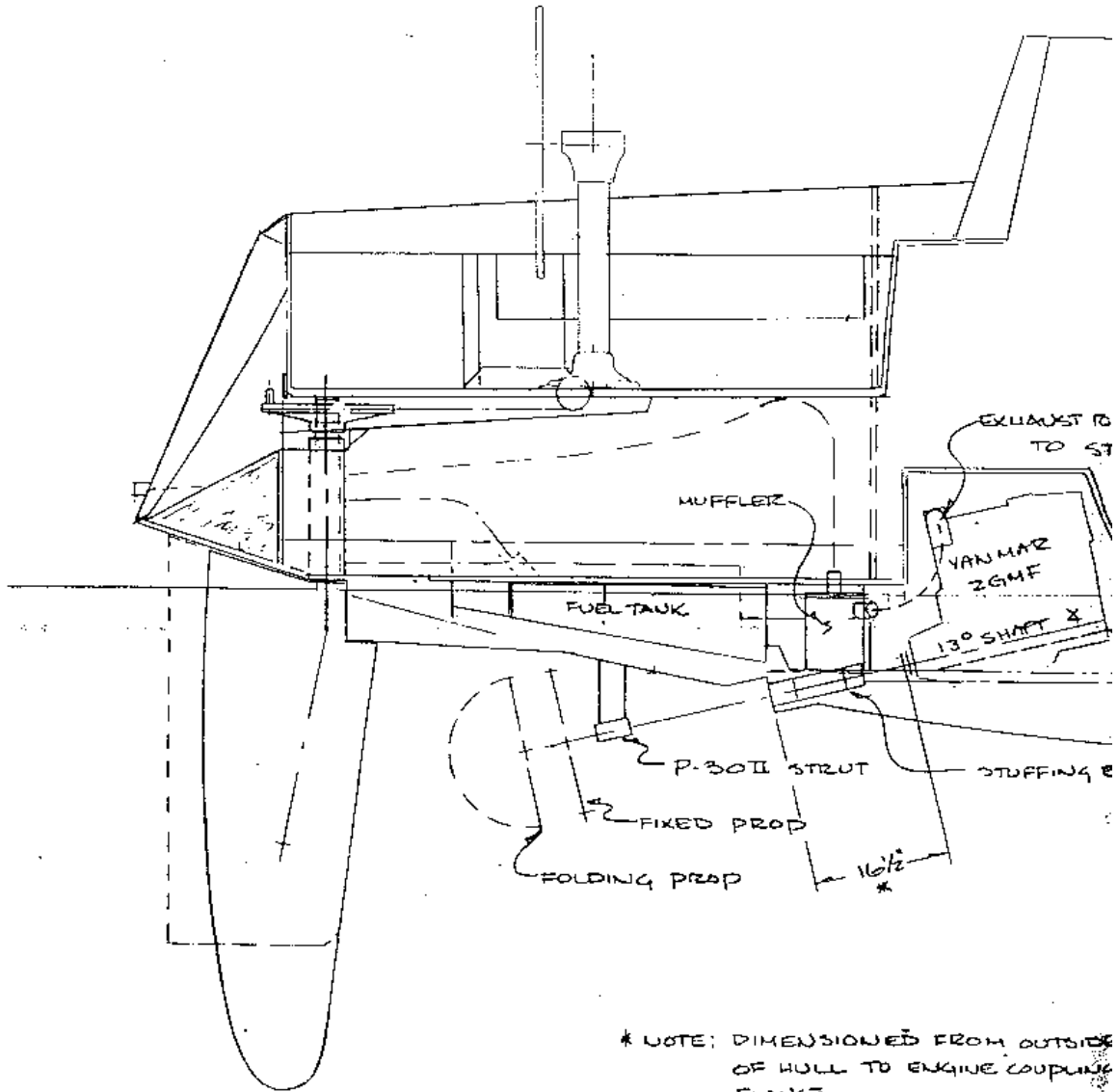

\* NOTE: DIMENSIONED FROM OUTSIDE OF HULL TO ENGINE COUPLING FLANGE.

## DRAWINGS AND KEEL BOLT TORQUE VALUES

## Section 9

The additional drawings are larger than a normal page. I have copied them so that you can fit the first two pages together to make drawing 1 and the second 2 pages together to make drawing 2

I also have a large blueprint that gives the sail plan. This is the drawing that was issued to the sail makers. I can have a copy produced mail it to you for the cost of the reproduction.

Contact me at:

Bill Crane

Billosail@aol.com

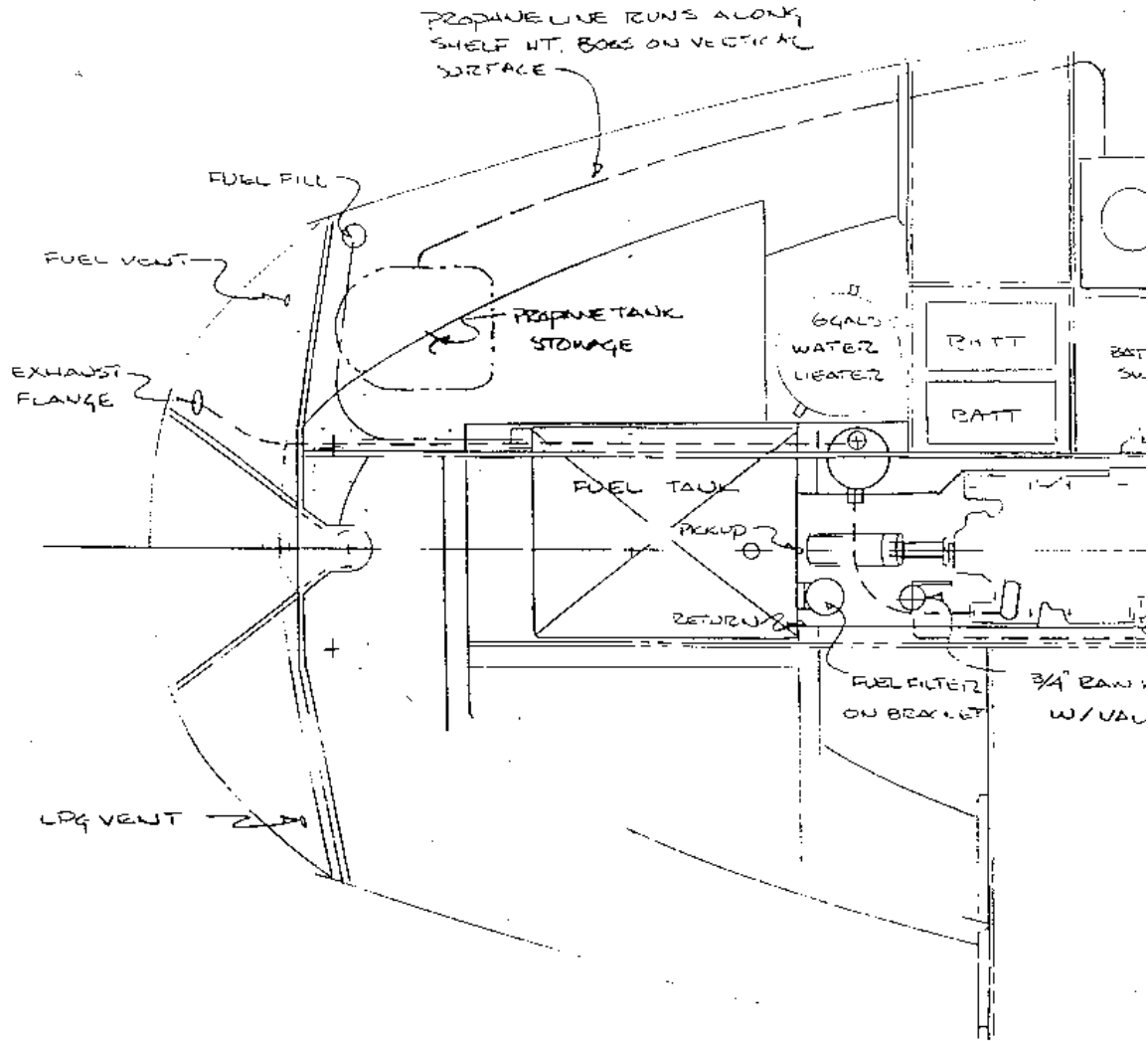

GENERAL NOTES

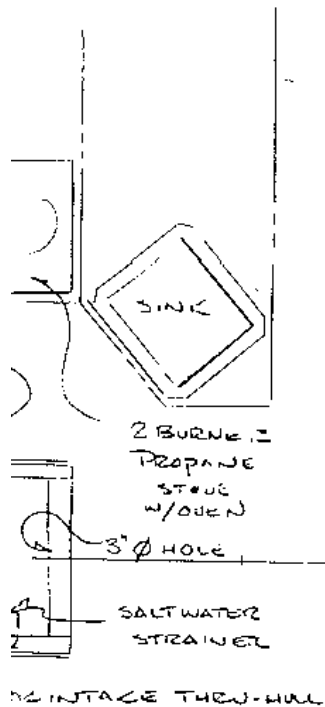

1. THROTTLE AND CLUTCH CABLES RUN INTO THE PORT SIDE OF THE LINER FROM THE LAZZARETTE AREA. THEY EXIT THE LINER AND RUN BELOW THE FUELTANK TO THEIR RESPECTIVE ATTACHMENT POINTS ON THE ENGINE.
2. THE ENGINE WIRING HARNESS RUNS FROM THE ENGINE PANEL ON THE PORT SIDE, ALONG THE UNDERSIDE OF THE COAMING TO THE FORWARD SAIL LOCKER BULKHEAD. IT THEN RUNS DOWN THE BULKHEAD TO THE ENGINE.
3. THE BILGE PUMP HOSE RUNS FROM THE BILGE PUMP, MOUNTED ON THE PORT BACKREST FACE 9" AFT OF THE SEAT LOCKER OPENING UNDER THE COAMING (THE WRAPPED TO THE UNDERSIDE OF THE WINCH ISLAND), TO THE FORWARD SAIL LOCKER BULKHEAD FROM WHICH POINT IT PASSES DOWN BELOW THE ENGINE INTO THE BILGE AREA FORWARD OF THE ENGINE.
4. THE 3" EXHAUST BLOWER MOUNTS TO THE BACKSIDE OF THE COCKPIT SIDE WALL (PORTSIDE). REFERENCE THE DECK PLAN. THE HOSE RUNS OUTBOARD BELOW THE WINCH ISLAND COAMING, FORWARD THEN INBOARD TO THE ENGINE ROOM. MOUNT OPEN END AT THE HIGHEST POINT CLOSEST TO THE EXHAUST ELBOW.
5. SEE PRESSURE WATER DRAWING TO DETAIL PUMP, TANK AND HOSE ROUTING.
- 6.

PEARSON 31 II

MACHINERY ARRANGEMENT

PLAN VIEW

SHT 1 OF 2

SCALE 3/4" = 1'-0"

D-3435

3-13-86  
C.L. WGTZ

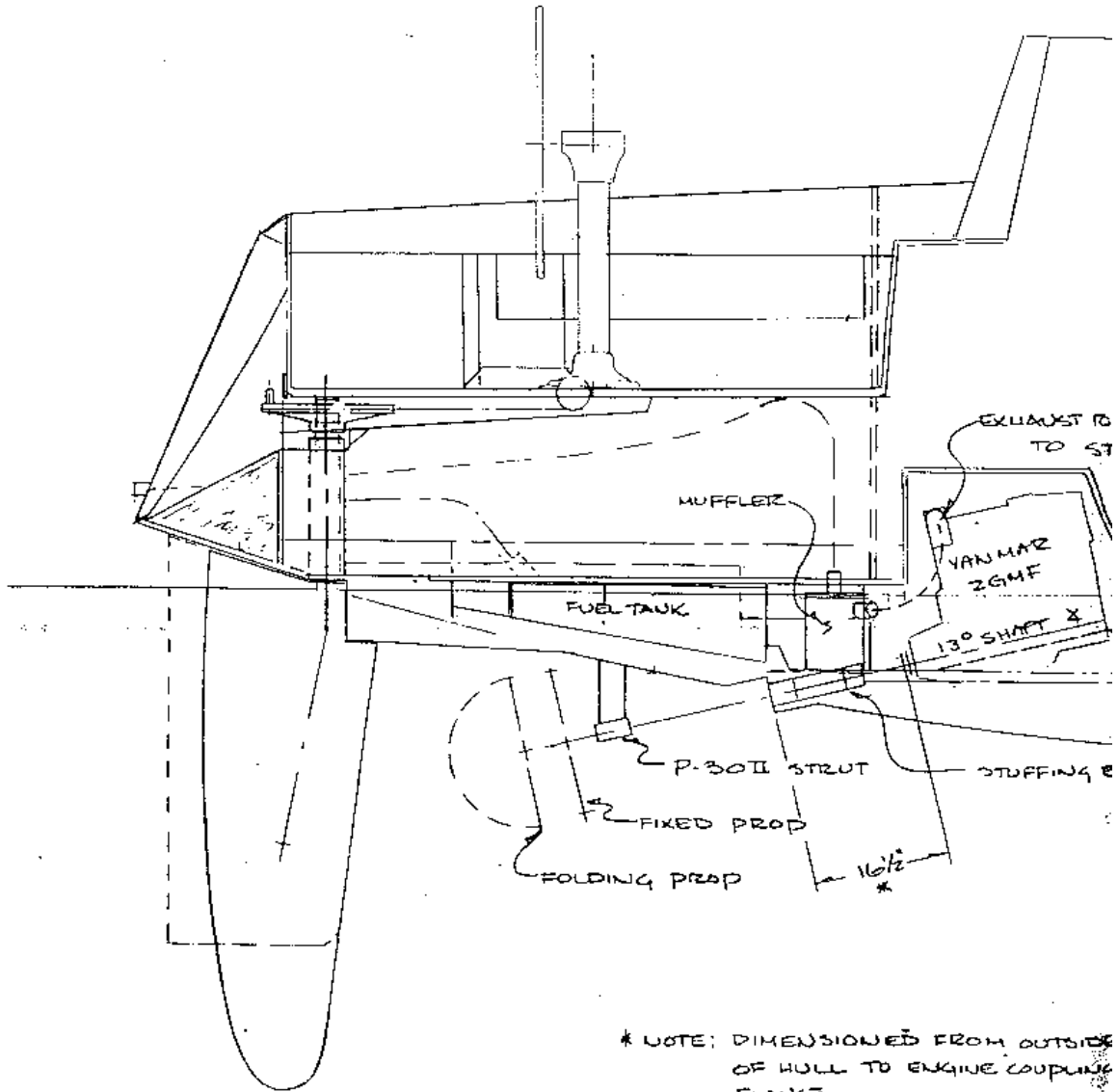

\* NOTE: DIMENSIONED FROM OUTSIDE OF HULL TO ENGINE COUPLING FLANGE.





TURNED

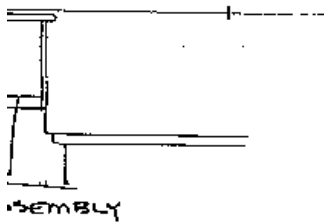

PEARSON 31-II

MACHINERY ARRANGEMENT

SHT 2 OF 2

SCALE:  $\frac{3}{4}'' = 1'-0''$

P-363.5

3-13-86  
ALL WGS

KEEL BOLT TORQUE VALUES  
WITH KEEL SUPPORTED

<u>BOAT</u>	<u>TORQUE</u>
P-27 WING KEEL:	
1/2" BOLTS	39 FT. - LBS.
3/4" BOLTS	125 FT. - LBS.
P-28 SHOAL KEEL:	
3/4" BOLTS	125 FT. - LBS.
P-28 FIN KEEL:	
3/4" BOLTS	125 FT. - LBS.
P-31 II WING KEEL:	
3/4" BOLTS	125 FT. - LBS.
P-31 II FIN KEEL:	
3/4" BOLTS	125 FT. - LBS.
1" BOLTS	280 FT. - LBS.
P-33 WING KEEL:	
3/4" BOLTS	125 FT. - LBS.
P-33 FIN KEEL:	
3/4" BOLTS	125 FT. - LBS.
1" BOLTS	280 FT. - LBS.
P-36 CENTERBOARDS:	
5/8" BOLTS	70 FT. - LBS.
1" BOLTS	280 FT. - LBS.
P-36 FIN KEEL:	
1" BOLTS	280 FT. - LBS.
P-37 WING KEEL:	
3/4" BOLTS	125 FT. - LBS.
P-39 FIN KEEL:	
3/4" BOLTS	125 FT. - LBS.

11-20-87